



General Catalog 2024

FOLLOW THE RED LINE



INDEX

• Leading the Future of CCTV Solutions	pag. 2
• Global presence	pag. 3
• Stepping Stones	pag. 3
• Provision-ISR's New Website	pag. 4
• Our Solution Ecosystem	pag. 5
• Protecting your privacy	pag. 6
• AI-Powered Video Analysis	pag. 7
• Ossia O.S.	pag. 10
• VMS - Video Management Software	pag. 13
• Provision CAM 2 Mobile APP	pag. 17
• IP B-Sight	pag. 21
• IP S-Sight	pag. 21
• IP Eye-Sight	pag. 26
• IP Smart-Sight Active deterrence camera	pag. 29
• IP Smart-Sight Active Thermal cameras	pag. 30
• IP Smart-Sight LPR cameras	pag. 31
• Digital Video Server	pag. 32
• IP Intelligent auto tracking PTZ	pag. 33
• Video Intercom - outdoor station	pag. 34
• Video Intercom - indoor station	pag. 35
• Video Intercom - Doorbell and chime	pag. 35
• Solar Cellular IP camera Kit	pag. 36
• NVR	pag. 38
• POE Switch & Accessories	pag. 42
• HD Basic	pag. 47
• HD PRO	pag. 47
• HD PTZ	pag. 50
• HYBRID DVR	pag. 52
• HDMI Accessories	pag. 56
• Balun	pag. 58
• Connectors	pag. 58
• Power supply	pag. 59
• Monitors	pag. 60
• Test monitors	pag. 60
• Keyboards	pag. 60
• Lenses	pag. 61
• Brackets and junction boxes	pag. 62
• OSSIA VMS Dedicated Hardware	pag. 66

Leading the Future of CCTV Solutions

Delivering Excellence in Security and Cybersecurity

Who We Are



Provision-ISR is an **Israeli multinational company** and one of the world's fastest-growing CCTV brands. We serve more than 40 countries across five continents with branches and official exclusive distributors working as partners to promote the brand in their regions.

Our Mission



At Provision-ISR, we aim to deliver **cutting-edge CCTV solutions** fortified by **state-of-the-art cybersecurity** and **advanced AI analytics** that safeguard people, property, and businesses. We're committed to providing high-quality products and exceptional support, exceeding industry standards.

Our Israeli DNA

Security Arena

Since its establishment, the geopolitical tensions that have affected Israel have prompted the industry to invest in emergency and crisis management in the security arena: **cyber security, intelligence, and critical infrastructure protection** allowing security manufacturers like Provision-ISR to gain unparalleled expertise in their field.



High-Tech and Cyber

As a Start-Up Nation, Israel is a central hub for **tech innovation**, especially in cybersecurity, positioning itself as a significant player in the broader high-tech landscape. This **commitment to excellence** extends to Provision-ISR, as we collaborate with **Check Point Software Technologies Ltd., a cybersecurity leader**. Today, more than ever, the security market must have protected and ready-to-use CCTV devices.



Our Approach and Ethics



Western Business Approach

Motivated by our Israeli DNA, our approach prioritizes lasting human connections. Grounded in respect and continual evolution, **we believe in forging enduring partnerships**. This approach reflects our commitment to collaboration, trust, and adaptability, which are essential for success in the dynamic global market.



Ethics

At Provision-ISR, our ethical commitment is a principle and a daily practice. **We safeguard every participant in the supply chain, from major distributors to small installers**, recognizing and respecting the unique professionalism each brings. Embodying a holistic approach, Provision-ISR views every link in the chain as **integral to perfection**. Those who choose Provision-ISR do so confidently, assured by the Brand's consistent demonstration of ethical values through actual actions, **encouraging trust and reliability** in every interaction.

Global presence

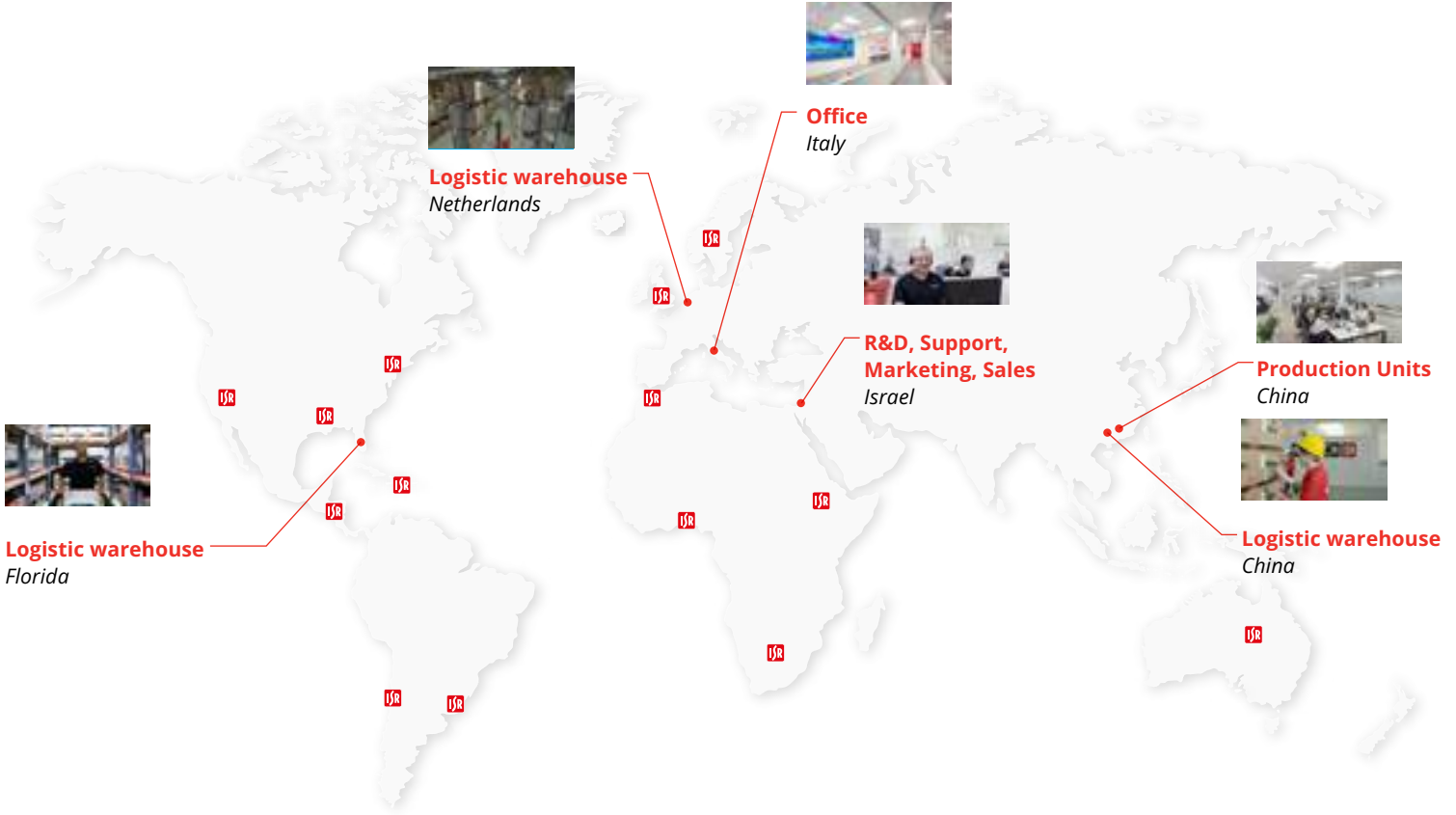

Stepping Stones

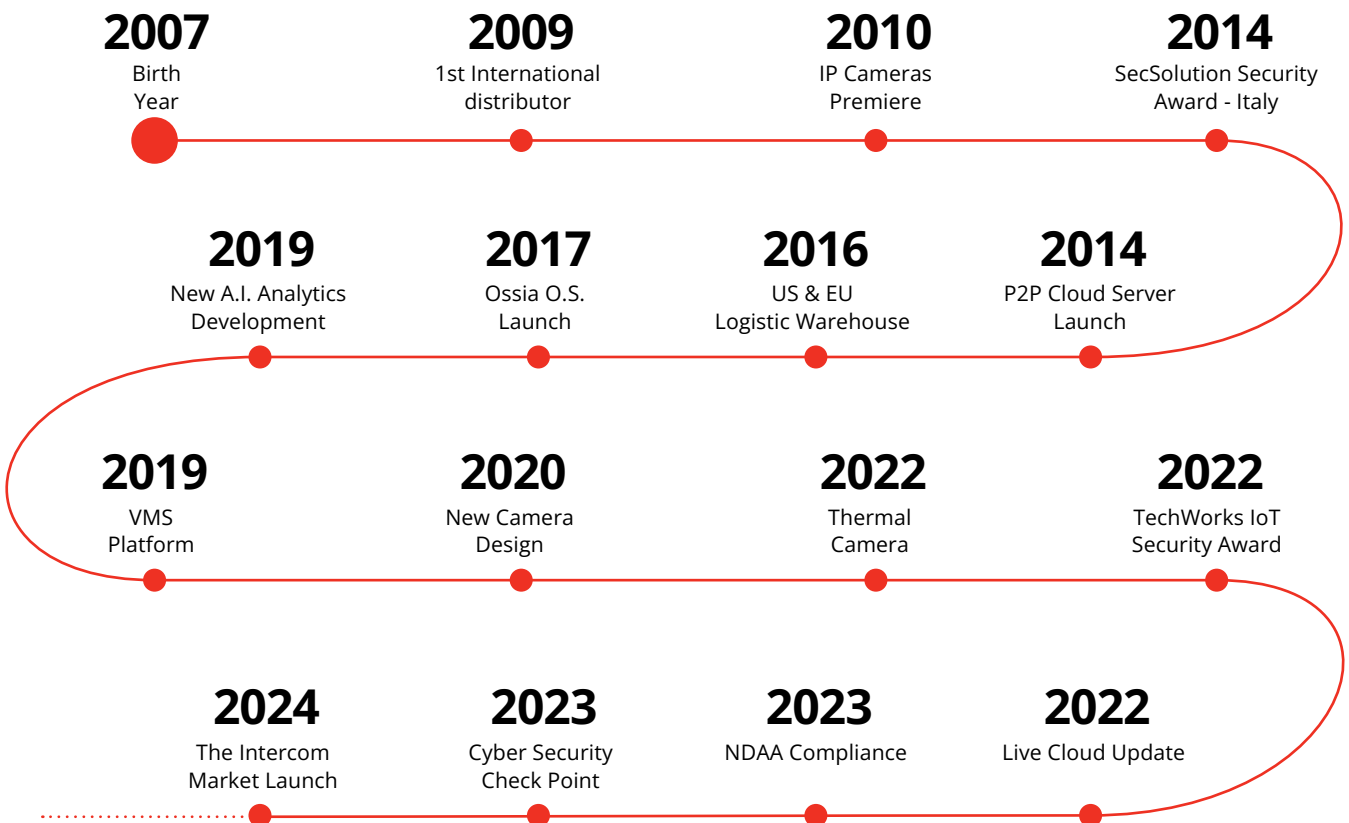

Introducing Provision-ISR's New Website: Your Digital Hub for Success

Empowering Installers and Distributors



A Streamlined Digital Experience:

Effortless Navigation: Locate the products you need quickly with our intuitive filtering system.

Invaluable Resources: Gain insights and best practices with in-depth case studies, informative tutorials, and comprehensive training resources.

Stay Informed: Get the latest updates on products, apps, and technology delivered straight to your fingertips.

Global Reach: Our platform seamlessly adapts to multiple languages, making it accessible no matter your location.

Dedicated Service: Easily access our open ticket support system and contact information to get the assistance you need, whenever you need it.

Connect, Learn, and Lead:

Connect: Stay informed and engaged with the latest industry trends.

Learn: Expand your knowledge with valuable resources to enhance your skills.

Lead: Become a true expert in your field by leveraging our comprehensive training materials.

Get Support: Enjoy peace of mind with our dedicated service options, including open ticket support and easy access to contact information.

Visit our website and discover your digital advantage!

www.provision-isr.com

Our Ecosystem Solution

Products, Software, and Solutions for Complete Security



The Provision-ISR Ecosystem: Comprehensive Hardware, Software, and Solutions

Provision-ISR offers a robust ecosystem of **hardware, software, and solutions** tailored to various surveillance needs. Our diverse **hardware** lineup includes advanced surveillance cameras—**Dome/Turret, Bullet, and PTZ**—designed for commercial, residential, industrial, and governmental sectors. Equipped with **built-in cybersecurity** and **AI analytics**, these cameras provide specialized functionalities such as **License Plate Recognition (LPR), thermal imaging, and face recognition**. Our **Network Video Recorders (NVRs)** and **Digital Video Recorders (DVRs)** support applications from small businesses to large enterprises, while our **VMS platform** enables centralized monitoring with **video walls, people tracking, maps, and more**. Complementing these are a wide range of accessories, making Provision-ISR a one-stop shop for security solutions.

Our **software** turns CCTV systems into proactive tools, utilizing **AI** to offer **loitering detection, sterile area monitoring, and access control** through face recognition. Developed by a skilled team in **Kfar Sava**, the software is **user-friendly**, with intuitive interfaces and customizable features. From the **Ossia recorder interface** to the **Provision Cam2 app** and the advanced **OSSIA VMS**, our software provides seamless control for both small setups and large-scale operations.

At the heart of our **solutions** is constant innovation, responding to market demands with technologies such as **color-at-night cameras, parking management systems, and thermal solutions** for fire prevention. With **ONVIF compliance** and **third-party integrations**, Provision-ISR delivers **turnkey solutions** that ensure security systems are adaptable, efficient, and future-ready.

Protecting your privacy

Focus in cyber security!

Cyber Security

Raising the bar in CCTV Cyber Security!

In an ever-evolving landscape of cyber threats, compromise on the cybersecurity of your CCTV is no longer an option. In collaboration with **global cybersecurity leader Check Point Software Technologies Ltd.** and their **integrated Quantum IoT Nano agent** that provides an advanced threat prevention layer against the common attack vectors at runtime, Provision-ISR leads a revolution in the CCTV industry, ensuring **unparalleled protection** against emerging threats.



NDAA

Provision-ISR is committed to offering products that **adhere to the exacting regulations** of the U.S. Department of Defence outlined in **Section 889 of the NDAA**.

In today's interconnected world, where security is paramount and threats of espionage dominate, **Provision-ISR guarantees product delivery that meets the highest security and regulatory requirements.**



GDPR

Since May 2018, the enactment of the European Privacy Regulation 2016/679, commonly referred to as GDPR (General Data Protection Regulation), has set the standard for safeguarding personal data.

At Provision-ISR, our **unwavering commitment to compliance** ensures that the information we retain as a manufacturer **remains secure and private**, and all our products strictly **adhere to the European GDPR.**



AI-Powered Video Analysis: A New Era of Surveillance

Revolutionizing Security through Advanced Object Recognition and Metadata Management.

AI is revolutionizing the way surveillance systems operate. By harnessing its power, cameras can go beyond simple recording to provide intelligent insights and proactive security. From detecting anomalies and suspicious behaviors to optimizing resource allocation and gaining valuable insights, AI-powered video analysis empowers you to make informed decisions, enhance compliance, and gain a competitive edge.

Imagine a surveillance system that not only records footage but also actively identifies potential threats, alerts you to suspicious activities, and helps you optimize your operations. With AI-powered video analysis, this is no longer a futuristic concept but a reality. By leveraging the power of artificial intelligence, your surveillance system can become a strategic asset that helps you protect your assets, improve efficiency, and drive business success.

General Analytics

Basic but essential functions that provide foundational security features, like Camera Tampering and Motion Detection.



Motion Detection

Older CCTV systems use basic motion detection to trigger recording or alerts by detecting changes in the camera's view. However, this method often causes false alarms from minor movements



Camera Masking

Camera masking detection alerts you instantly when a camera is being blocked or covered by spray or objects, ensuring you're aware of any attempts to disable your security system.



Camera Offsetting

Camera offset detection notifies you immediately when a camera has been tampered with or shifted from its original position, ensuring your surveillance stays focused on the intended areas.

DDA1 (A.I. Object Recognition)

Provision-ISR's DDA™ Video Analytics uses object recognition technology (and thus advanced artificial intelligence algorithms) to differentiate **between humans, two-wheeled, and four-wheeled vehicles.**

Thanks to this technology, the system will only trigger alarms or push notifications when the object of interest violates the pre-set rules. This **significantly reduces false alarms** caused by external factors like rain, shadows, changes in lighting, moving vegetation, or passing animals.



DDA1 Sterile Area

Keep the area safe with unauthorized access detection, alerts, and regulatory compliance.



DDA1 Line Crossing

Accurately detects human and vehicle intrusions, ensuring perimeter security.



DDA1 Object Counting (Line)

Monitor customer flow with precision to manage store capacity, staffing, and peak times effectively.

DDA1 (A.I. Object Recognition)



DDA1 Object Counting (Area)

Manage checkout lines efficiently by tracking queue lengths, improving customer satisfaction and staff deployment.



DDA1 Loitering Detection

Identifies loiterers, enabling prompt staff intervention to ensure children's safety from threats.



DDA1 Illegal Parking Detection

Identifies and alerts about unauthorized parking in restricted zones or fire lanes, ensuring compliance and enhancing safety.

DDA2 (A.I. Advanced Object Classification)

With the advanced artificial intelligence embedded in Provision-ISR cameras, we've eliminated false alarms by accurately identifying humans, two-wheeled and four-wheeled vehicles. Now, we take it a **step further with the second-generation DDA™ Video Analytics**. By having the ability to **show detailed metadata** analysis for each object type, we ensure unparalleled precision in surveillance, minimizing false alarms and enhancing security efficiency.

Second-generation DDA™ can analyze surveillance images more accurately. For example, this can improve the efficiency of forensic investigations by providing critical information for suspect identification and event reconstruction.



Metadata for 4-Wheeled

Brand (Mazda, Renault, Volkswagen, Etc.), Color, Model (Golf, Kangoo, Tucson, Etc.), Type (Car, SUV, Bus, Etc.), and Year.



Metadata for 2-Wheeled

Type (Bicycle, Electric Bicycle, Motorcycle, Tricycle).



Metadata for Humans

Age Estimation, Backpack, Gender, Glasses, Handbag, Hat, Mask, Lower and Upper Clothes Type & Color, Direction of Movement.

A.I. Face Detection and Recognition

This group focuses on functions related to facial detection and recognition, essential for security systems that require precise identification.

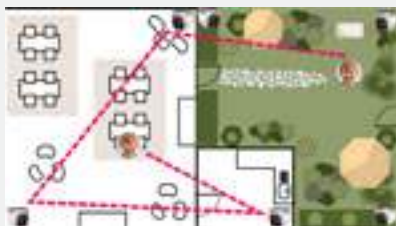

Face detection

Utilizes advanced facial recognition to quickly identify and locate individuals, enhancing security.



Face recognition

Boost security and manage staff effectively by using facial recognition for access control.

Special features

Include more unique features like License Plate Recognition (LPR), Parking Lot Management, Fire Detection, and Temperature Monitoring.



AI (Heatmap)

Analyzes movement patterns to optimize space layout and enhance the overall user experience.



Audio Exception

Detects sudden changes in ambient sound, alerting in case of unexpected noises starting or stopping to ensure safety and asset protection.



LPR (License Plate Recognition)

Monitors license plates in surrounding areas, enhancing security and access control.



Fire Detection

Provides early fire detection to minimize potential damage to assets and infrastructure.



Temperature Monitoring



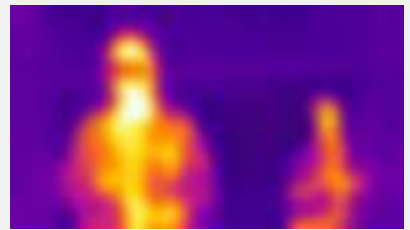

Measure, monitor, and control temperature for optimal performance and safety.



Thermal Imaging.

Ensure the security and integrity of your materials with precise monitoring and control.

Hardware/ Analytics Table

		B-Sight Cameras 	S-Sight Cameras 	Eye-Sight Cameras 	Smart-Sight Cameras 	NVR	S-Sight PTZ 	Eye-Sight PTZ 
General Analytics	Camera Masking	v	v	v	v		v	v
	Camera Offsetting	v	v	v	v		v	v
DDA  (A.I. Object Recognition)	DDA1 Sterile Area	v	v	v	v	v	v	v
	DDA1 Line Crossing	v	v	v	v	v	v	v
	DDA1 Object Counting (Line)			v	v			v
	DDA1 Object Counting (Area)			v	v			
	DDA1 Loitering Detection			v	v			
	DDA1 Illegal Parking Detection			v	v			
DDA  (A.I. Advanced Object Classification)	Metadata for 4-Wheeled			v				
	Metadata for 2-Wheeled			v				
	Metadata for Humans			v				
A.I. Face Detection and Recognition	Face detection			v	v	v		v
	Face recognition			o	v	o		v
Special features	AI (Heatmap)			v				
	Audio Exception			v	v			
	LPR (License Plate Recognition)				v			
	Small Parking Lot management				o	o		
	Fire Detection				v			
	Temperature analysis				v			
	Thermal analysis				v			
	Combined Analytics					v		
Object Smart Tracking						v	v	

o = Require NVR

Ossia O.S.

Simple and Intuitive Operating System by Provision-ISR.



Ossia is the latest OS for Provision-ISR's DVR/NVR systems, it is one of the most innovative operating system in the market. As the heart of your system it's present rich and advance features, answering all your surveillance needs.

Applications



Private houses



Small/medium business



Buildings

Key Features



Web Interface + Remote Cloud Access

Experience the full advantages of the Ossia OS on an identical interface between local and web, including remote access via our cloud platform, provisionizr-cloud.com.



Analytics Dedicated Interface

Search and backup based on object attributes, including Humans, Vehicles, License plates, and Human Faces.



Search Playback And Backup

Enjoy features such as the time-slice search, which helps to find a playback in no time.



Over-Map Face Track

Upload a map, and track a chosen face over it.



Burglar Alarm

CCTV and alarm systems are now seamlessly connected! Control system triggers like recording, push notifications, sirens, and more using the arm/disarm function on any burglar system



Security At Highest Priority

Protect IP-connected CCTV systems from cyber attacks with Check Point's IoT Protect Nano Agent, ensuring real-time protection and built-in firmware security for Provision-ISR devices.

Ossia O.S. Key Features



Batch Playback Handling

Multiple channels playback, backup, or delete in a Single click.



In Channel Appearance

Easily choose what data is visible on the channel, along with objects, faces, plates, and more.



Statistics Variations

Choose the time - and get instant traffic statistics for humans and vehicles which occurred at that specific time.



Device Cloud Updates

Stay effortlessly up to date with our innovative cloud update feature!



Intuitive operations

Audio broadcast, immediate alarm/relay activation, instant playback, and many more at a click of a button.



Parking Lot Management

Parking lot management feature offers seamless monitoring, license plate recognition, and efficient space utilization, ensuring enhanced security and operational efficiency for parking facilities.

VMS - Video Management Software

Intelligent web-client video management platform



Ossia VMS is an advanced and reliable Video Management Software specifically designed for CCTV systems featuring multiple devices controlled from a Single reliable platform. Centralized monitoring across bank branches, campus facilities, chain stores, or industrial complexes - provides operators with at-a-glance verification of incidents and management of multiple cameras through real-time floor plans and intelligent mapping features. The Ossia VMS solution provides a flexible operational approach for operators and manned guarding teams. The platform enables a rapid and decisive response to any incident with its unique and tailored features.

Standard version



Ossia VMS STANDARD VERSION supports up to 256 channels and is 100% License Free.

Enterprise version

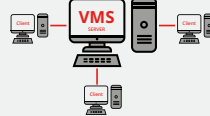

Ossia VMS ENTERPRISE VERSION supports up to 10,000 channels and is a license-based platform.

Vertical markets



Shopping centers



Governments institutes



Governments institutes

Ossia VMS Key Features



Main interface - live view

Complete live view control, including Fish-Eye views, PTZ Control, Instant Playback, Audio broadcast, Manual alarm activation, and many more.



Main interface - playback view

View playback from the recorder/storage server, back up multiple cameras at once and combine a face/license plate for your search.



SOP - Standard Operating Procedure

Predefined actions to be followed by the operator based on specific events.



E-Map Live Monitoring & Face Tracking

Integrate Google Maps or custom maps for real-time event locations during live E-Map monitoring. Use VMS to search faces across devices and track movements within your custom E-Map.

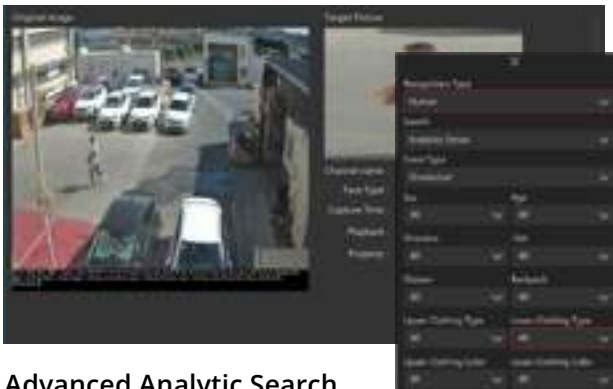

Advanced Analytic Search

Use the VMS to search for faces across multiple devices and follow a face path over the E-map you have created.



Customized dashboard

Build your data dashboard with the displays of your choice out of the wide variety of the VMS features, such as analytics, videos, maps, playbacks, etc.

Ossia VMS Key Features



Decoding by dedicated HW

Create a custom video wall canvas with our TV Wall. Drag & drop live feeds, playback, and alarms for up to 144 channels. Each window is flexible - monitor live, review past events, or display alerts. Get unmatched situational awareness, your way.



Remote settings

Set your devices straight from the VMS, starting from the most basic motion detection to the more advanced features such as DDA analytics and face detection.



System health monitor

The system health monitor allows the user to see the system and connected devices' status visually. It shows connectivity, alarm status, number of channels, and more. The user can even connect directly to his device's web client.



Alarm view

Choose which events will pop up on your monitor, including the specific event details.



LPR monitoring

Got a parking lot you need to manage? Now you can! The LPR monitoring can be used to fully manage a parking lot, including receiving entrance/exit statistics.



Management Mode

Focus on Management, Not Monitoring: Optimize your VMS with streamlined device management, face and license plate databases, and connections for up to 10,000 devices. Minimize server load with a 16-channel live view limit to reduce hardware costs and boost efficiency.

Ossia VMS Key Features



Object counting and occupancy control

Ossia VMS uses counting cameras for real-time occupancy data, managing flow with entry limits and customizable tasks. It offers triggers and real-time data, comparing statistics, and visualizing traffic in graphs and tables.



Interactive Help Guides

Use the Interactive Help Guide for easy setup. Its flow chart simplifies configuring popular modules like video monitoring and TV wall setups.



Access Control Function

Our access control module supports real-time monitoring, displays door statuses, and enables one-click operations. Use E-Map Live Monitoring to map access devices for live operations and view alarm information.



People Group Management

Effortlessly manage permission groups with schedules and triggers. Sync database groups from Ossia VMS to intercom, NVRs, and IPCs for efficient access management.



Vehicle Group Management

Direct synchronization of license plates with LPR devices ensures continuous operation, even during connection losses. From one central location, our VMS now lets you categorize license plates into groups and push these groups to different NVRs and LPR IPCs seamlessly.



VMS User Scheduled Access

This feature ensures security for shift workers and multi-staffed monitoring stations. Set precise schedules, camera access, and permissions to prevent unauthorized entry. Denied access for users outside designated schedules enhances control and security.

Provision CAM 2 Mobile APP

The App you always dreamt of is in the pocket of your jeans.



Provision Cam2 is the installers' first choice for their professional needs, yet clear-cut to be the end-users favorite App for everyday surveillance.
 Provision Cam2 is a free iOS and Android App.

Key Features



AI-based playback



Face database management



Sharing

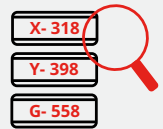

LPR search



Fish-eye support



QR code sharing



Talk and listen capabilities



Account based

Provision Cam2 Key Features



DDA analytics search

Search events by specific analytics and object attributes for precise, time-saving efficiency.



Simple Playback Filtering

Easily search and find specific event playbacks!



Freedom of choice

Provision-ISR App allows you to choose what's best for you!



It's all about sharing

Share your video playbacks on any social media you like with a click of a button.



All you need is APP

Access all the features you can do locally on your recording device from the App



Face recognition

Capture faces directly and keep your face database!



Notify me

Always stay connected by getting push notifications!



Account access

Account-based users can now sign in from any other phone and get all their device lists



Johnson Control Integration

One App to Control It All. Control DSC or Visonic alarms directly through the CAM 2 app, plus bind zones with cameras to get visual alarm verifications.

IP Series



B-Sight

2MP - 4MP

Our B-Sight series provide you with everything you need for a Basic installation. B-Sight cameras guarantee a superior image quality, improved night performance and make an outstanding value for money solution.



S-Sight

2MP - 4MP - 8MP

Our S-Sight series provide you with everything you need for a SIMPLE installation. S-Sight cameras guarantee a superior image quality, improved night performance and make an outstanding value for money solution and enhanced video analytics functions based on Artificial Intelligence (DDA™ Video Analytics and Face Recognition).



Eye-Sight

2MP - 4MP - 6MP - 8MP

Our Eye-Sight series aims at the security professionals seeking a proficient line featuring outstanding image quality, full connectivity, and enhanced video analytics functions based on Artificial Intelligence (DDA™ Video Analytics and Face Recognition).



Smart-Sight

2MP - 4MP - 5MP

Our Smart-Sight Series includes high-performance AI Cameras designed for specific purposes and applications. The Smart-Sight components: the sensor, optics, CPU, lighting, Etc., were specially selected to deliver the most accurate AI results for the required application.



Intelligent auto tracking PTZ

2MP - 4MP

If you're monitoring large areas such as parking lots, industrial sites, or convention centers, Provision-ISR PTZ cameras allow you to monitor the overall area and focus on suspicious activity.



IP Cameras

Model name index

Bullet / Dome / Turret

Example: D I - 3 2 0 IPSN - VF G - V

Example: I 4 - 3 2 0 IPSN - VF G - V

Category	CMOS	LUX	Lens	Check Point protect
B Body	3 ~ 1/3"	0 0 (IR on)	28 2.8mm	V2
D Dome		1 Below ~ 0.009	36 3.6mm	V3 CP protect
FE Fish-Eye		2 0.01 ~ 0.1	37 3.7mm	V4 CP protect dual system
I Infra-Red (IR) Bullet			VF Vari-focal	
M Mini			MVF Motorized VF (auto focus)	
T Tube			MVF1 2.8-12mm MVF	
BS Bullet Small			MVF2 7-22mm MVF	
BM Bullet Medium			3 3mm thermal lens	
IV IR PIR detector			7 7mm thermal lens	

Sub-Category		Resolution		Solution		Color	
X	No sub-category	2	2 MP	WIP5	H.265 WIFI	G	Grey
AI	Anti vandal (IR)	3	3 MP	IPSN	S-Sight NDAA		
C	Pinhole cone shape	4	4 MP	IPSR	Rainbow S-Sight		
I	Infra-Red (IR)	5	5 MP	IPERN	Rainbow Eye-Sight		
MA	Mini Anti Vandal	6	6 MP	IPB	IP Basic		
2	IR 20 m	8	8 MP	SRN	S-Sight Rainbow		
3	IR 30 m			IPEN	Eye-Sight NDAA		
4	IR 40 m			LPR	License Plate Recognition		
6	IR 60 m			FR	Face Recognition		
L	Light			AD	Active Deterrence		
V	White Led			IPN	NDAA		
H	White Led + IR Led			Thermal	Thermal camera		
				WIPSN	S-Sight NDAA WIFI		

Bullet PTZ

Example: I5 PT - 3 2 0 - IPM X4 P

Example: I5 PT - 3 2 0 - IPM X10 P

IR Distance	Category	CMOS	Resolution	LUX	Solution	Zoom	Special features
I5 50 m	PT Pan Tilt	3 ~ 1/3"	2 2 MP	0 0(IR on)	IPM MStar	X4 x4 zoom X10 x10 zoom	P POE

Speed dome

Example: MZ - 20 IP - 2 (IR)







Example: Z6 - 32 IPE - 4 (IR)

Category	Lens	Solution	Resolution	Special features
Z Speed dome	20 x20 zoom	IP/IPE IP	2 2 MP	(IR) Infra-Red
MZ Mini Speed dome	25 x25 zoom	IPM MStar	4 4 MP	
Z3 Speed dome 3"				
Z4 Speed dome 4"	32 x32 zoom			
Z5 Speed dome 5"				
Z6 Speed dome 6"				



B-Sight 2 MP





AI (Object Recognition): DDA Sterile Area (Human only), DDA Line Crossing (Human only).

	DH-320IPBN-28	BSH-320IPBN-28
	 	 
NDAA		
Lens	2.8mm (93°)	2.8mm (93°)
Illumination	20m (1 High-Power IR LED) 20m (1 High-Power White LED)	20m (1 High-Power IR LED) 20m (1 High-Power White LED)
Audio	Built-in Microphone	Built-in Microphone
Brackets/ Junction Box	Pag. 62 - G (not PR-JB12IP64)	Pag. 62 - A



B-Sight 4 MP







AI (Object Recognition): DDA Sterile Area (Human only), DDA Line Crossing (Human only).

	DH-340IPBN-28	BSH-340IPBN-28
	 	 
NDAA		
Lens	2.8mm (93°)	2.8mm (93°)
Illumination	20m (1 High-Power IR LED) 20m (1 High-Power White LED)	20m (1 High-Power IR LED) 20m (1 High-Power White LED)
Audio	Built-in Microphone	Built-in Microphone
Brackets/ Junction Box	Pag. 62 - G (not PR-JB12IP64)	Pag. 62 - A



S-Sight 2 MP

Basic analytics (Motion detection, Camera Tampering), A.I. Analytics (S-Sight DDA1), Remote Monitoring (Browser, Cam2 App, Ossia VMS)

	DI-320IPSN-28-V4	DI-320IPSN-28-G-V4	DV-320SRN-28
			 
Cyber Protection			-
NDAA			
Lens	2.8mm (107°)		2.8mm (105.2°)
Illumination	20m (1 High Power IR LED)		25m (2 High-Power White LED)
Audio	Built-in Microphone		Built-in Microphone
SD Card	Up to 256 Gb		Up to 128 Gb
Brackets/ Junction Box	Pag. 62 - G		Pag. 62 - G



S-Sight 2 MP

Basic analytics (Motion detection, Camera Tampering), A.I. Analytics (S-Sight DDA1), Remote Monitoring (Browser, Cam2 App, Ossia VMS)

	DI-320IPSN-VF-V4	DI-320IPSN-VF-G	DH-320SRN-MVF
Cyber Protection		-	-
NDAAs			
Lens	2.8-12mm Vari-Focal (88°-34.8°)		2.8-12mm MVF with Auto Focus (105.4°-34°)
Illumination	40m (3 High Power IR LED)		40m (1 High-Power IR LED 40m (2 High-Power White LED)
Audio	Built-in Microphone		Built-in Microphone
SD Card	Up to 256 Gb		Up to 128 Gb
Brackets/ Junction Box	Pag. 62 - F		Pag. 62 - G





	I2-320IPSN-28-V4	I2-320IPSN-28-G-V2	BSV-320SRN-36	BMV-320SRN-36
Cyber Protection		-	-	-
NDAAs		-		
Lens	2.8mm (107°)	-	3.6mm (84.6°)	3.6mm (89°)
Illumination	20m (1 High Power IR LED)	-	25m (2 High-Power White LED)	40m (3 High Power White LED)
Audio	-	-	Built-In Microphone	Built-In Microphone + 1 IN
SD Card	Up to 256 Gb	-	Up to 128 Gb	Up to 128 Gb
Brackets/ Junction Box	Pag. 62 - A	-	Pag. 62 - G	Pag. 62 - G





	I4-320IPSN-VF-V4	BMH-320SRN-MVF	IV-320IPSN-37
Cyber Protection		-	-
NDAAs			
Lens	2.8-12mm Vari-Focal (94°-35.7°)	2.8-12mm MVF with Auto Focus (105.4°-34°)	3.7mm (83°)
Illumination	40m (2 High Power IR LED)	40m (1 High-Power IR LED) 40m (2 High-Power White LED)	10m (20 Invisible IR LED)
Audio	-	Built-In Microphone + 1 IN	Built-In Microphone + 1 IN
SD Card	Up to 256 Gb	Up to 128 Gb	Up to 256 Gb
Brackets/ Junction Box	Pag. 62 - B	Pag. 62 - G	-





S-Sight 4 MP

Basic analytics (Motion detection, Camera Tampering), A.I. Analytics (S-Sight DDA1), Remote Monitoring (Browser, Cam2 App, Ossia VMS)

	DI-340IPSN-28-V2 	DI-340IPSN-28-G-V2 	DV-340SRN-28 
Cyber Protection	-		-
NDAA			
Lens	2.8mm (110°)		2.8mm (99°)
Illumination	20m (1 High Power IR LED)		25m (2 High-Power White LED)
Audio	Built-In Microphone		Built-In Microphone + 1IN
SD Card	Up to 256 Gb		Up to 256 Gb
Brackets/ Junction Box	Pag. 62 - G		Pag. 62 - G

	DI-340IPSN-MVF-V2 	DI-340IPSN-MVF-G-V2 	DV-340SRN-MVF 
Cyber Protection	-		-
NDAA			
Lens	2.8-12mm MVF with Auto Focus (94°-35.7°)		2.8-12mm MVF with Auto Focus (105.4°-34°)
Illumination	40m (3 High Power IR LED)		40m (1 High-Power IR LED) 40m (2 High-Power White LED)
Audio	Built-In Microphone		Built-In Microphone + 1IN
SD Card	Up to 256 Gb		Up to 256 Gb
Brackets/ Junction Box	Pag. 62 - F		Pag. 62 - F

	I2-340IPSN-28-V2 	I2-340IPSN-28-G-V2 	BSV-340SRN-36 
Cyber Protection	-		-
NDAA			
Lens	2.8mm (110°)		3.6mm (98°)
Illumination	20m (1 High Power IR LED)		25m (2 High-Power White LED)
Audio	-		1 IN
SD Card	Up to 256 Gb		Up to 256 Gb
Brackets/ Junction Box	Pag. 62 - A		Pag. 62 - A

	BMV-340SRN-36 	I4-340IPSN-MVF-V2 	BMH-340SRN-MVF 
Cyber Protection	-	-	-
NDAA			
Lens	3.6mm (79°)	2.8-12mm MVF with Auto Focus (94°-35.7°)	2.8-12mm MVF with Auto Focus (97°-33°)
Illumination	20m (1 High Power IR LED)	25m (2 High-Power White LED)	40m (1 High-Power IR LED) 40m (2 High-Power White LED)
Audio	-	1 IN	Built-In Microphone + 1 IN
SD Card	Up to 256 Gb	Up to 256 Gb	Up to 256 Gb
Brackets/ Junction Box	Pag. 62 - A	Pag. 62 - A	Pag. 62 - A



S-Sight WIFI 4 MP









Basic analytics (Motion detection, Camera Tampering), A.I. Analytics (S-Sight DDA1), Remote Monitoring (Browser, Cam2 App, Ossia VMS)

	I2-340WIPSN-28 
Cyber Protection	-
NDAA	
Lens	2.8mm (110°)
Illumination	20m (1 High-Power IR LED)
Audio	Built-In Microphone + 1IN
SD Card	Up to 256 Gb
Brackets/ Junction Box	Pag. 62 - G



S-Sight 5 MP















Basic analytics (Motion detection, Camera Tampering), A.I. Analytics (S-Sight DDA1), Remote Monitoring (Browser, Cam2 App, Ossia VMS)

	DAI-350IPSN-28-V4 	DI-350IPSN-28-V4 	DMA-350IPSN-28-V4 
Cyber Protection			
NDAA			
Lens	2.8mm (108°)	2.8mm (104°)	2.8mm (108°)
Illumination	20m (2 High-Power IR LED)	20m (1 High-Power IR LED)	10m (2 High-Power IR LED)
Audio	Built-In Microphone + 1 IN	Built-In Microphone + 1 IN	Built-In Microphone + 1 IN
SD Card	Up to 256 Gb	Up to 256 Gb	Up to 256 Gb
Brackets/ Junction Box	Pag. 62 - G	Pag. 62 - G	Pag. 62 - G



S-Sight 8 MP









Basic analytics (Motion detection, Camera Tampering), A.I. Analytics (S-Sight DDA1), Remote Monitoring (Browser, Cam2 App, Ossia VMS)





	DI-380IPSN-28-V3 	DI-380IPSN-28-G-V3 	DI-380IPSN-MVF-V3 	DI-380IPSN-MVF-G-V3 
Cyber Protection				
NDA				
Lens	2.8mm (112°)		2.8-12mm MVF with Auto Focus (102.7°- 32.2°)	
Illumination	20m (1 High Power IR LED)		40m (3 High Power IR LED)	
Audio	Built-In Microphone + 1IN		Built-In Microphone + 1IN	
SD Card	Up to 256 Gb		Up to 256 Gb	
Brackets/ Junction Box	Pag. 62 - G		Pag. 62 - F	
	14-380IPSN-28-V3 			14-380IPSN-MVF-V3 
Cyber Protection				
NDA				
Lens	2.8mm (112°)		2.8-12mm MVF with Auto Focus (102.7°- 32.2°)	
Illumination	40m (2 High Power IR LED)		40m (2 High Power IR LED)	
Audio	1IN		1IN	
SD Card	Up to 256 Gb		Up to 256 Gb	
Brackets/ Junction Box	Pag. 62 - B		Pag. 62 - B	



Eye-Sight 2 MP

Basic analytics (Motion detection, Camera Tampering), A.I. Analytics (Eye-Sight DDA1, Eye-Sight DDA2), Remote Monitoring (Browser, Cam2 App, Ossia VMS)







	DAI-320IPEN-28-V4	DAI-320IPEN-MVF-V4	DI-320IPEN-28-V4	DI-320IPEN-MVF-V4
				
Cyber Protection				
NDAA				
Lens	2.8mm (112°)	2.8-12mm MVF with Auto Focus (103°-32°)	2.8mm (108°)	2.8-12mm MVF with Auto Focus (103°-32°)
Illumination	20m (3 High Power IR LED)	40m (2 High Power IR LED)	20m (1 High Power IR LED)	40m (3 High Power IR LED)
Audio	Built-In Microphone + 1IN	Built-In Microphone + 1IN +1OUT	Built-In Microphone + 1IN	Built-In Microphone + 1IN
Alarm	1 IN + 1 OUT	1 IN + 1 OUT	-	-
SD Card	Up to 256 Gb	Up to 256 Gb	Up to 256 Gb	Up to 256 Gb
Brackets/ Junction Box	Pag. 62 - I	Pag. 62 - H	Pag. 62 - G	Pag. 62 - F

	DMA-320IPEN-28-V4	I4-320IPEN-36-V4	I4-320IPEN-MVF-V4	I6-320IPEN-MVF-V4
				
Cyber Protection				
NDAA				
Lens	2.8mm (108°)	3.6mm (89°)	2.8-12mm MVF with Auto Focus (103°-32°)	2.8-12mm MVF with Auto Focus (103°-32°)
Illumination	20m (3 High Power IR LED)	40m (2 High Power IR LED)	40m (2 High Power IR LED)	60m (4 High Power IR LED)
Audio	Built-In Microphone + 1IN	1IN	1IN	1 IN + 1 OUT
Alarm	-	-	-	1 IN + 1 OUT
SD Card	Up to 256 Gb	Up to 256 Gb	Up to 256 Gb	Up to 256 Gb
Brackets/ Junction Box	Pag. 62 - E	Pag. 62 - B	Pag. 62 - B	Pag. 62 - C



Eye-Sight 4 MP

Basic analytics (Motion detection, Camera Tampering), A.I. Analytics (Eye-Sight DDA1, Eye-Sight DDA2), Remote Monitoring (Browser, Cam2 App, Ossia VMS)

	DAI-340IPEN-28-V4	DAI-340IPEN-MVF-V4
		
Cyber Protection		
NDAA		
Lens	2.8mm (100°)	2.8-12mm MVF with Auto Focus (98°-28°)
Illumination	20m (3 High Power IR LED)	40m (2 High-Power IR LED)
Audio	Built-In Microphone + 1IN	Built-In Microphone + 1IN +1OUT
Alarm	1 IN + 1 OUT	1 IN + 1 OUT
SD Card	Up to 256 Gb	Up to 256 Gb
Brackets/ Junction Box	Pag. 62 - I	Pag. 62 - H







	DI-340IPEN-28-V4	DI-340IPEN-28-G-V4	DI-340IPEN-MVF-V4	DMA-340IPEN-28-V4
				
Cyber Protection				
NDAA				
Lens	2.8mm (100°)	2.8mm (100°)	2.8-12mm MVF with Auto Focus (94.3°-29.9°)	2.8mm (100°)
Illumination	20m (1 High Power IR LED)	20m (1 High Power IR LED)	40m (3 High Power IR LED)	10m (2 High Power IR LED)
Audio	Built-In Microphone + 1IN	Built-In Microphone + 1IN	Built-In Microphone + 1IN +1OUT	Built-In Microphone + 1 IN
Alarm	-	-	-	-
SD Card	Up to 256 Gb	Up to 256 Gb	Up to 256 Gb	Up to 256 Gb
Brackets/ Junction Box	Pag. 62 - G	Pag. 62 - G	Pag. 62 - H	Pag. 62 - H









	I4-340IPEN-36-V4	I4-340IPEN-36-G	I4-340IPEN-MVF-V4	I6-340IPEN-MVF-V4	I6-340IPEN-MVF-G-V4
					
Cyber Protection					
NDAA					
Lens	3.6mm (80.6°)	3.6mm (80.6°)	2.8-12mm MVF with Auto Focus (94.3°-29.9°)	2.8-12mm MVF with Auto Focus (105°-33°)	2.8-12mm MVF with Auto Focus (105°-33°)
Illumination	40m (2 High Power IR LED)	40m (2 High Power IR LED)	40m (3 High Power IR LED)	60m (4 High-Power IR LED)	60m (4 High-Power IR LED)
Audio	1 IN	1 IN	Built-In Microphone + 1IN +1OUT	Built-In Microphone + 1 IN	Built-In Microphone + 1 IN
Alarm	-	-	-	1 IN + 1 OUT	1 IN + 1 OUT
SD Card	Up to 256 Gb	Up to 256 Gb	Up to 256 Gb	Up to 256 Gb	Up to 256 Gb
Brackets/ Junction Box	Pag. 62 - G	Pag. 62 - G	Pag. 62 - H	Pag. 62 - H	Pag. 62 - H









Eye-Sight 6 MP

Basic analytics (Motion detection, Camera Tampering), A.I. Analytics (Eye-Sight DDA1, Eye-Sight DDA2), Remote Monitoring (Browser, Cam2 App, Ossia VMS)

	DI-360IPEN-28-V4	DI-360IPEN-MVF-V4
		
Cyber Protection		
NDAA		
Lens	2.8mm (104°)	2.8-12mm MVF with Auto Focus (112°-35°)
Illumination	20m (3 High Power IR LED)	40m (2 High-Power IR LED)
Audio	Built-In Microphone + 1IN +1OUT	Built-In Microphone + 1IN +1OUT
Alarm	-	1 IN + 1 OUT
SD Card	Up to 256 Gb	Up to 256 Gb
Brackets/ Junction Box	Pag. 62 - I	Pag. 62 - H

	DAI-360IPEN-28-V4	DAI-360IPEN-MVF-V4	DMA-360IPEN-28-V4
			
Cyber Protection			
NDAA			
Lens	2.8mm (104°)	2.8-12mm MVF with Auto Focus (108°-36°)	2.8mm (100°)
Illumination	20m (1 High-Power IR LED)	40m (3 High-Power IR LEDs)	20m (2 High-Power IR LEDs)
Audio	Built-In Microphone + 1IN +1OUT	Built-In Microphone + 1IN +1OUT	Built-In Microphone + 1IN +1OUT
Alarm	1 IN + 1 OUT	1 IN + 1 OUT	1 IN + 1 OUT
SD Card	Up to 256 Gb	Up to 256 Gb	Up to 256 Gb
Brackets/ Junction Box	Pag. 62 - I	Pag. 62 - H	Pag. 62 - H

	I4-360IPEN-36-V4	I4-360IPEN-MVF-V4	I6-360IPEN-MVF-V4
			
Cyber Protection			
NDAA			
Lens	3.6mm (78°)	2.8-12mm MVF with Auto Focus (108°-35°)	2.8-12mm MVF with Auto Focus (106°-35°)
Illumination	40m (2 High-Power IR LEDs)	40m (3 High-Power IR LEDs)	60m (4 High-Power IR LEDs)
Audio	Built-In Microphone + 1IN +1OUT	Built-In Microphone + 1IN +1OUT	Built-In Microphone + 1IN +1OUT
Alarm	1 IN + 1 OUT	1 IN + 1 OUT	1 IN + 1 OUT
SD Card	Up to 256 Gb	Up to 256 Gb	Up to 256 Gb
Brackets/ Junction Box	Pag. 62 - I	Pag. 62 - H	Pag. 62 - H



Eye-Sight 8 MP

Basic analytics (Motion detection, Camera Tampering), A.I. Analytics (Eye-Sight DDA1, Eye-Sight DDA2), Remote Monitoring (Browser, Cam2 App, Ossia VMS)

	DAI-380IPEN-MVF-V3	DI-380IPEN-MVF-V3	DI-380IPEN-MVF-G-V3	I6-380IPEN-MVF-V3
Cyber Protection				
NDAAs				
Lens	2.8-12mm MVF with Auto Focus (96°- 32°)	2.8-12mm MVFI with Auto Focus (96°- 32°)	2.8-12mm MVFI with Auto Focus (96°- 32°)	2.8-12mm MVF with Auto Focus (96°- 32°)
Illumination	40m (2 High Power IR LED)	40m (3 High Power IR LED)	40m (3 High Power IR LED)	60m (4 High Power IR LED)
Audio	Built-In Microphone + 1 IN + 1 OUT	Built-In Microphone + 1 IN	Built-In Microphone + 1 IN	1 IN + 1 OUT
Alarm	1 IN + 1 OUT	-	-	1 IN + 1 OUT
SD Card	Up to 256 Gb	Up to 256 Gb	Up to 256 Gb	Up to 256 Gb
Brackets/ Junction Box	Pag. 62 - I	Pag. 62 - H	Pag. 62 - H	Pag. 62 - H



Smart-Sight active deterrence 4 MP

















Basic analytics (Motion detection, Camera Tampering), A.I. Analytics (Eye-Sight DDA1, Eye-Sight DDA2), Remote Monitoring (Browser, Cam2 App, Ossia VMS)

	DH-340ADN-MVF-V4	BMH-340ADN-MVF-V4
Cyber Protection		
NDAAs		
Lens	2.8-12mm MVF with Auto Focus (94.2°-29.8°)	2.8-12mm MVF with Auto Focus (94.2°-29.8°)
Illumination	40m (1 High-Power IR LED) + 40m (1 High-Power White LEDs) + Red/Blue Strobe Lights	40m (1 High-Power IR LED) + 40m (1 High-Power White LEDs) + Red/Blue Strobe Lights
Audio	Built-In Microphone + 1 IN + 1 OUT - Built-In Speaker	1 IN - Built-In Speaker
Alarm	1 IN + 1 OUT	1 IN + 1 OUT
SD Card	Up to 256 Gb	Up to 256 Gb
Brackets/ Junction Box	Pag. 62 - I	Pag. 62 - H



Smart-Sight Thermal 5 MP

Basic analytics (Motion detection, Camera Tampering), Remote Monitoring (Browser, Cam2 App, Ossia VMS)

	BMH-THERMAL-3-V2	BMH-THERMAL-7-V2
	 	 
Cyber Protection		
NDAAs		
Resolution	Optical: 2592x1944 (5MP) - Thermal: 256x192	Optical: 2592x1944 (5MP) - Thermal: 256x192
Lens	Optical: 4mm (80°) - Thermal: 3mm (60°)	Optical: 8mm (37°) - Thermal: 7mm (26°)
Illumination	20m (2 High-Power IR LED) White Strobe light	20m (2 High-Power IR LED) White Strobe light
Optical e Thermal image overlay	Yes	Yes
Audio	Built-in speaker + Audio input	Built-in speaker + Audio input
Alarm	1 IN + 1 OUT	1 IN + 1 OUT
SD Card	Up to 256 Gb	Up to 256 Gb
Brackets/ Junction Box	Pag. 62 - I	Pag. 62 - H
	BLH-THERMAL-19	BLH-THERMAL-25
	 	 
Cyber Protection		
NDAAs		
Resolution	Optical: 2592x1944 (5MP) - Thermal: 256x192	Optical: 2592x1944 (5MP) - Thermal: 256x192
Lens	Optical: 12mm (26.6°) - Thermal: 19mm (19.5°)	Optical: 16mm (19.8°) - Thermal: 25mm (15°)
Illumination	80m (2 High-Power IR LED) + White Strobe light	80m (2 High-Power IR LED) + White Strobe light
Optical e Thermal image overlay	Yes	Yes
Audio	Built-in speaker + Audio input	Built-in speaker + Audio input
Alarm	1 IN + 1 OUT	1 IN + 1 OUT
SD Card	Up to 256 Gb	Up to 256 Gb
Brackets/ Junction Box	Pag. 62 - I	Pag. 62 - H



Smart-Sight LPR 2 MP







Basic analytics (Motion detection, Camera Tampering) Remote Monitoring (Browser, Cam2 App, Ossia VMS)

	I6-320LPR-MVF1	I6-320LPR-MVF2
		
		
Cyber Protection	-	-
NDAA	-	-
Lens	2.8-12mm MVF (103.4°-32.4°)	2.8-12mm MVF (103.4°-32.4°)
Illumination	60m (4 High Power IR LED)	60m (4 High Power IR LED)
Audio	1 IN + 1 OUT	1 IN + 1 OUT
Alarm	1 IN + 1 OUT	1 IN + 1 OUT
Detection distance	1.05m-14.32m	1.97m-26.87m
Plate database	10000 Plates	10000 Plates
SD Card	Up to 256 Gb	Up to 256 Gb
Brackets/ Junction Box	Pag. 62 - I	Pag. 62 - H



Smart-Sight LPR 4 MP

Basic analytics (Motion detection, Camera Tampering), Remote Monitoring (Browser, Cam2 App, Ossia VMS)

	I6-340LPRN-MVF1	I6-340LPRN-MVF2
		
		
		
Cyber Protection	-	-
NDAA	-	-
Lens	2.8-12mm MVF (103.4°-32.4°)	2.8-12mm MVF (103.4°-32.4°)
Illumination	60m (4 High Power IR LED)	60m (4 High Power IR LED)
Audio	1 IN + 1 OUT	1 IN + 1 OUT
Alarm	1 IN + 1 OUT	1 IN + 1 OUT
Detection distance	1.05m-14.32m	1.97m-26.87m
Plate database	10000 Plates	10000 Plates
SD Card	Up to 256 Gb	Up to 256 Gb
Brackets/ Junction Box	Pag. 62 - I	Pag. 62 - H

IP Cameras 6 - 4 MP

Basic analytics (Motion detection, Camera Tampering), A.I. Analytics (Eye-Sight DDA1, Eye-Sight DDA2), Remote Monitoring (Browser, Cam2 App, Ossia VMS)

	FEI-360IPN-V3 	BX-341IPEN 
Cyber Protection		-
NDAAs		
Lens	1.65mm (360° for Ceiling Mount / 180° For Wall Mount)	-
Illumination	15m (4 High-Power IR LEDs)	-
Audio	Built-In Microphone + 1 IN + 1 OUT	Built-In Microphone + 1 IN + 1 OUT
Alarm	1 IN + 1 OUT	2 IN + 2 OUT
SD Card	Up to 256 Gb	Up to 256 Gb
Brackets/ Junction Box	Pag. 62 - I	-

Digital Video Server 5 MP

Digital Video Server Supporting 4 Analog Technologies With Alarms.

Basic analytics (Camera Tampering), AI (Object Recognition): DDA Sterile Area, DDA Line Crossing, DDA Object Counting (Line), DDA Object Counting (Area), AI (Face Detection): 10 Faces per frame, AI: Heatmap

	DVS-IPEN-5 
Audio	1 IN + 1 OUT
Alarm	8 IN + 4 OUT
SD Card	Up to 256 Gb

PTZ 2 MP

Basic analytics (Motion detection, Camera Tampering), A.I. Analytics (Eye-Sight DDA1, Eye-Sight DDA2), Remote Monitoring (Browser, Cam2 App, Ossia VMS)

	I5PT-320IPMX4-P 	I5PT-320IPMX10-P 	MZ-20IPM-2(IR) 
Resolution	2MP	2MP	2MP
Lens	x4 (2.8-12mm)	x10 (5,1-51 mm)	x20 (F1.6~4.9mm - F3.5~98mm)
Pan/Tilt range	250° Pan / 65° Tilt	250° Pan Rotation 65° Continuous Tilt	360° (Endless) / 0°~180° (Auto Flip)
IR Distance	50 m	50 m	80 m
Power supply	DC12V/2A (excluding) PoE(~10W)	DC12V/2A (excluding) PoE(~10W)	12v/3A
Brackets/ junction box	-	-	Pag. 52



PTZ 2 MP





Basic analytics (Motion detection, Camera Tampering), A.I. Analytics (Eye-Sight DDA1, Eye-Sight DDA2), Remote Monitoring (Browser, Cam2 App, Ossia VMS)

	Z3-4ADSN-4 	Z4-25IPEN-2(IR) 	Z5-25IPEN-2(IR) 
NDAА			
Lens	X4 2.8mm (F1.6) - 12mm (F2.7)	x 25 4.8mm (F1.65) - 120mm (F3.8)	x 25 4.8mm (F1.65) - 120mm (F3.8)
Pan / Tilt Range		360° (Endless) / 180° (Auto Flip)	360° (Endless) / 180° (Auto Flip)
Illumination	Smart 50m IR LED - 30m White LED	Smart IR 100 m	Smart IR 150 m
Smart tracking	Auto Tracking based on object recognition	Auto Tracking based on object recognition	Auto Tracking based on object recognition
Audio	1 IN - 1 OUT	-	1 IN - 1 OUT
Alarm	1 IN - 1 OUT	-	1 IN - 1 OUT
Brackets/ Junction Box	Pag. 62 - L + bracket included	Pag. 62 - L + bracket included	Pag. 62 - L + bracket included



PTZ 4 MP

Basic analytics (Motion detection, Camera Tampering), A.I. Analytics (Eye-Sight DDA1, Eye-Sight DDA2), Remote Monitoring (Browser, Cam2 App, Ossia VMS)

	Z4-25IPEN-4(IR) 	Z5-25IPEN-4(IR) 	Z6-32IPE-4(IR) 
NDAА			-
Lens	x 25 4.8mm (F1.65) - 120mm (F3.8)	x 25 4.8mm (F1.65) - 120mm (F3.8)	x 32 5.6mm (F1.55) - 179.2mm (F3.4)
Pan / Tilt Range	360° (Endless) / 180° (Auto Flip)	360° (Endless) / 180° (Auto Flip)	360° (Endless) / 220° (Continuous)
Illumination	Smart IR 100 m	Smart IR 150 m	Smart IR 200 m
Smart tracking	Auto Tracking based on object recognition	Auto Tracking based on object recognition	Auto Tracking based on object recognition
Audio	-	1 IN - 1 OUT	1 IN - 1 OUT
Alarm	-	1 IN - 1 OUT	2 IN - 2 OUT
Brackets/ Junction Box	Pag. 62 - L + bracket included	Pag. 62 - L + bracket included	Pag. 62 - L + bracket included

Video Intercom System

Safety starts at the doorstep with Provision-ISR technology.



INT-320WIPN

Our Intercom System utilizes advanced **Deep 3D facial recognition** for precise identification, paired with a **high-resolution WDR camera**, wide-angle **2.3mm lens**, **IR night vision**, and **2.4GHz Wi-Fi/Ethernet connectivity** for clear footage. With Power over Ethernet (**PoE**) for easy installation and compatibility with iOS/Android, which offers **local storage** (up to 256GB SD Card), it prioritizes privacy with end-to-end encryption, complying with **NDA policies & restrictions**.

Configurable Access Control provides personalized security with customizable options for a **2-step authentication process**. The Built-in Microphone and Speaker offer crystal-clear **two-way audio** for seamless visitor interaction. A dedicated Call Button simplifies communication, granting direct access to corresponding monitors (up to 8), the Cam2 App, and the Ossia VMS system. Additionally, the Intercom System's Weather-Resistant Design, with an **IP65 rating**, ensures durability in all weather conditions.



- Max. resolution: 2MP (1920×1080 25/30FPS)
- Lens: 2.3mm with a wide field of view 132° Horizontal
- True WDR (12odB), BLC, HLC, ROI
- 3D Face Detection & Face Recognition Technology
- Access control function supporting Mifare & EMC RFID proximity cards
- Wireless 802.11b/g/n 2.4GHz
- 2-Way Audio Built-in Microphone & Speaker
- 2m IR LED lights
- Tampering alarm support
- Remote Monitoring: IE Browsing, VMS Software, Provision Cam2 Mobile App
- Door Lock support; Door Sensor Support; Open Door Button
- IP65 Rating - dust ingress and water jets



MON-TCH7

With its **standalone functionality**, the 7" frame monitor is an independent powerhouse, yet when paired with our Intercom, it transforms into the **ultimate control center**.

Equipped with advanced features, this indoor monitor unit serves as a central hub for surveillance camera integration, offering live views of up to **4 cameras simultaneously**, and with **two-way audio**, one-way video, and **door-unlocking capabilities**, it provides unparalleled convenience and functionality.

The monitor supports microSD cards up to 256GB for **local storage**, automatically capturing snapshots of callers and recording video footage for later review. You can enjoy a personalized experience with **custom ringtones** and a **do-not-disturb option**, and with connectivity options like Ethernet, **PoE**, and **2.4GHz Wi-Fi**, as well as **8 alarm inputs** for sensors, stay informed and in control at all times.

- Screen Size: 7" IPS Touch Screen
- Max. resolution: 1024x600
- Brightness: 300cd/m2
- Compression: H.265+ / H.265 / H.264 / MJPEG
- SD Card: Manual Record (up to 256GB)
- 8CH input
- Wireless 802.11b/g/n 2.4GHz
- 2-Way Audio: Built-in Microphone & Speaker
- ONVIF Support
- Weight: ~360g
- Power: DC12V/~200mA / PoE/~6W



DB-320WIPN

Doorbell cameras, also known as Video Doorbells, are smart home security devices that allow homeowners to keep an eye on their front door and receive alerts when someone approaches or rings the Doorbell. By incorporating artificial intelligence algorithms, the Doorbell can analyze and interpret video footage, thus providing more advanced features and functionality.



- Max. resolution: 2MP (1920×1080)
- Lens: 2.3mm @F2.2 with a wide field of view 139° Horizontal
- Face Detection Technology
- Access control function supporting Mifare proximity cards
- Wireless 802.11b/g/n 2.4GHz
- 2-Way Audio Built-in Microphone & Speaker
- 2 IR and 1 customizable white LED lights
- Tampering alarm and door contact alarm support
- Remote Monitoring: IE Browsing, VMS Software, Provision Cam2 Mobile App
- Exit Button support; Door Unlock wiring 1 NO 1 NC
- IP65 Rating - Protected from water spray from any direction

PR-CHIME

Radio-based Chime with 8 different tones and 5 volume levels



- 8 Tones
- Magnetic mounting
- Magnetic separate base for nonmagnetic areas
- Adjustable volume
- Low battery reminder

Solar Cellular IP Camera Kit

Solar Brilliance & Cellular Resilience - Powering Your Protection



SOL1-240ADSRN-36

This state-of-the-art security solution harnesses the power of the sun and cellular connectivity for unparalleled performance and eco-friendliness. Ideal for residential, commercial, and industrial settings, this advanced standalone camera redefines surveillance with its wireless design and high-tech features.

With its comprehensive kit, our Solar Cellular IP Camera sets a new standard for convenience and reliability with no wiring hassles and effortless installation and operation.



Artificial Intelligence

Provision-ISR's DDA™ Video Analytics technology distinguishes between humans, 2-wheeled, and 4-wheeled vehicles, improving surveillance accuracy. The DDA™ system includes line crossing and sterile area monitoring for thorough security coverage.



Smart Alert

Flash and sound serve as deterrents (strobe light and speaker). When the camera detects a DDA™ Analytics event, you can opt for on-site alerts via strobe lighting, pre-recorded message, or both, bolstering security with visible and audible deterrents.



Color Night Vision

Unlike traditional methods reliant on infrared illumination, our Solar Cellular IP Camera redefines low-light monitoring by capturing vibrant, full-color images even in the darkest environments.

Technology Overview

Our Solar Cellular IP Camera is a reliable and flexible security solution that uses solar power, whether direct sunlight or just regular daylight, ensuring continuous operation without needing external power sources. Its durable aluminium and polycarbonate construction maintains cellular signal integrity and withstands harsh weather conditions.



Specification Highlights

- Max. resolution: 4MP (2560×1440)
- Lens: 3.6mm 92° Horizontal
- 24/7 Full-Color Day Mode
- 2 High-Power White LED: Full power: 20m Low power: 10m
- Red/Blue Strobe lights
- 1-Way Audio Audio in and Built-in Microphone & Speaker
- General Analytics: Camera Tampering
- AI (Object Recognition): DDA Sterile Area, DDA Line Crossing
- PIR: Angle - Horizontal 82° / Vertical 50° Range - up to 15m
- IP65 Rating for IP camera / IP67 Rating for Solar Panel
- Remote Monitoring: IE Browsing, VMS Software, Provision Cam2 Mobile App

NVR

Network Video Recorders



In standard installations - the NVR is the heart of the IP System.

It is responsible for smooth communication with the cameras and the constant recording of all the data received from the connected cameras.

Unlike DVRs, the NVR doesn't compress the video Signal received from the IP camera but only stores it the same way as the camera already compresses it.

CONVENTIONAL NVRs

These NVRs are connected to the network and communicate with the IP cameras through the general network, without a direct IP camera connection. This provides the installer the highest flexibility in the design of the system and the wiring. Basic knowledge in networking and general IP configuration is required.

POE NVRs





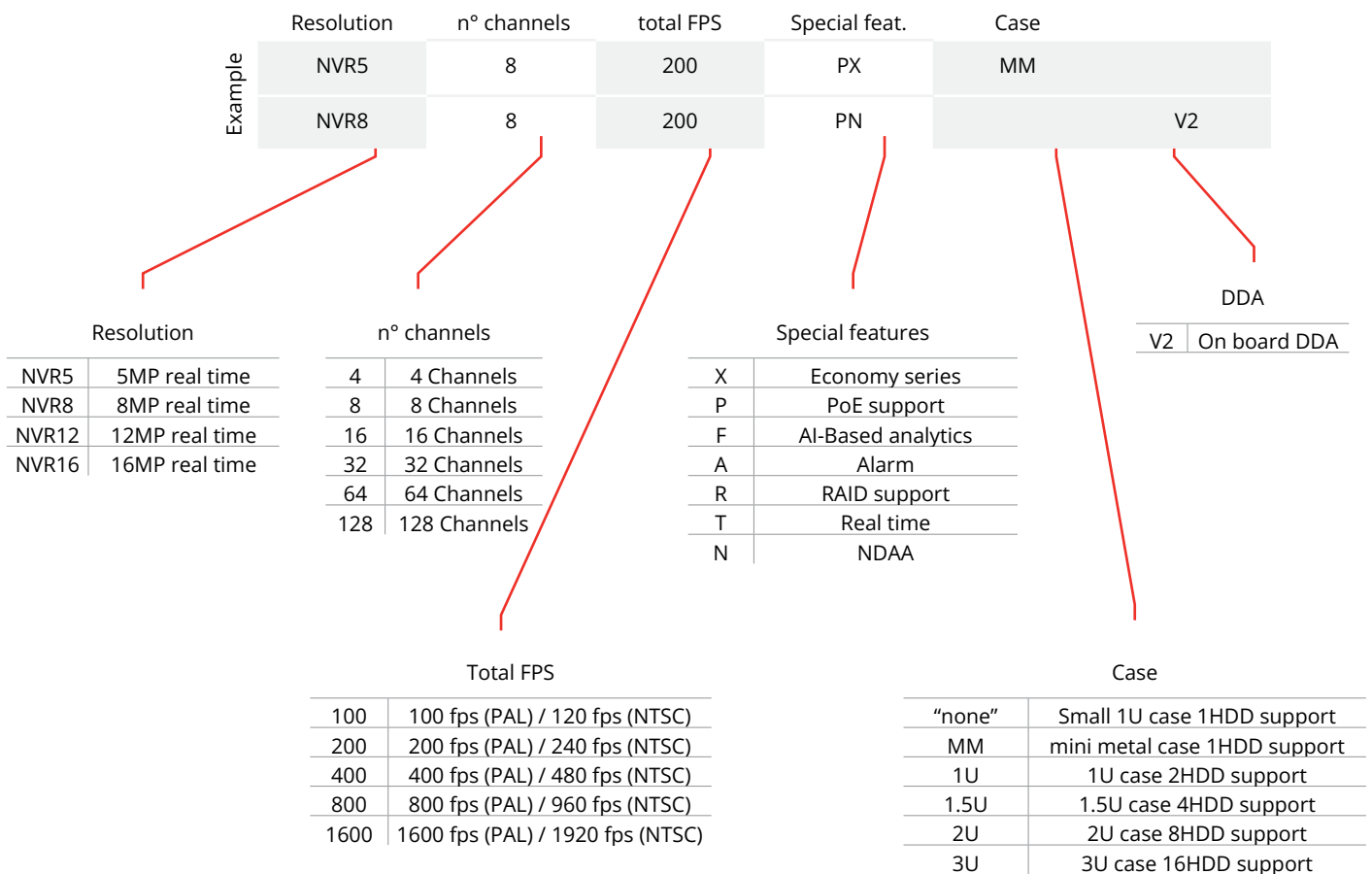



These NVRs perform as a local network switch by creating a closed internal network for the IP cameras. The IP cameras are connected directly to the NVR by one network cable which will provide PoE power and automatically configure the camera for display & record. These NVRs may also perform as conventional NVRs by dedicating some channels to communicating with any ONVIF camera connected to the network. No previous knowledge is required for this type of installation.



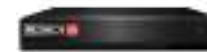







Model name index



NVR 4-8 CH

Real-time recording of all channels, H.265, Backup format AVI/DAT/MP4, VMS Support, Provision Cam2 APP Support, Remote connection via APP & Web page.

		NVR5-4100XN(MM)	NVR5-4100PXN(MM)	NVR8-4100PN-V2	NVR5-8200XN(MM)
					
Channels		4	4	4	8
Max. resolution		5 MP	5 MP	8 MP	5 MP
Cyber Security		-	-		-
NDAAs					
Video output		HDMI: 1080P VGA: 1280X1024	HDMI: 1080P VGA: 1280X1024	HDMI (4K), VGA (1080P)	HDMI: 1080P VGA: 1280X1024
POE Ports / CCTV mode		-	4 - CCTV mode (200m)	4 - CCTV mode (200m)	-
A.I. DDA™		Yes	Yes	Yes	Yes
Face Recognition		-	-	-	-
LPR		Yes	Yes	Yes	Yes
Snapshots A.I. Live View by menu		-	-	Yes	-
		Yes	Yes	Yes	Yes
Fish-Eye Dewarp		Web Only	Web Only	Web Only	Web Only
Thermal Support		(Limited Support)	Yes	Yes	(Limited Support)
Alarms		Based on IPC only	Based on IPC only	Based on IPC only	Based on IPC only
Hard Disk		1 x SATA (Up to 6TB)	1 x SATA (Up to 6TB)	1 x SATA (Up to 10TB)	1 x SATA (Up to 6TB)

		NVR5-8200PXN(MM)	NVR8-8200N-V2	NVR8-8200PN-V2	NVR12-8200FAN
					
Channels		8	8	8	8
Max. resolution		5 MP	8 MP	8 MP	8 MP
Cyber Security		-			
NDAAs					
Video output		HDMI: 1080P VGA: 1280X1024	HDMI: 4K 1080P VGA: 1280X1024	HDMI: 4K 1080P VGA: 1280X1024	HDMI: 4K VGA: 1280X1024
POE Ports / CCTV mode		8 - CCTV mode (200m)	-	8 - CCTV mode (200m)	-
A.I. DDA™		Yes	Yes	Yes	Yes
Face Recognition		-	-	-	Yes
LPR		Yes	Yes	Yes	Yes
Snapshots A.I. Live View by menu		-	Yes	Yes	Yes
		Yes	Yes	Yes	Yes
Fish-Eye Dewarp		Web Only	Web Only	Web Only	Yes
Thermal Support		(Limited Support)	Yes	Yes	Yes
Alarms		Based on IPC only	Based on IPC only	Based on IPC only	8 IN / 4 OUT
Hard Disk		1 x SATA (Up to 6TB)	1 SATA (8 TB Max)	1 x SATA (Up to 10TB)	1 SATA (8 TB Max)







NVR 8 - 16 CH

Real-time recording of all channels, H.265, Backup format AVI/DAT/MP4, VMS Support, Provision Cam2 APP Support, Remote connection via APP & Web page.

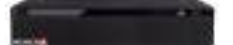
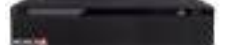
		NVR12-8200PFAN	NVR8-16400AN(1U)-V2	NVR12-16400FAN(1U)	NVR12-16400PFAN(1U)
					
Channels		8	16	16	16
Max. resolution		8 MP	8 MP	12 MP	12 MP
Cyber Security					
NDAAs					
Video output		HDMI: 4K VGA: 1280X1024	HDMI: 4K, 1080P VGA: 1280X1024	HDMI: 4K VGA: 1280X1024	HDMI: 4K VGA: 1280X1024
POE Ports / CCTV mode		8	-	-	16
A.I.	DDA™	Yes	Yes	Yes	Yes
	Face Recognition	Yes	-	Yes	Yes
	LPR	Yes	Yes	Yes	Yes
Snapshots A.I.	Live View by menu	Yes	-	Yes	Yes
		Yes	Yes	Yes	Yes
Fish-Eye Dewarp		Yes	Yes	Yes	Yes
Thermal Support		Yes	Yes	(Limited Support)	(Limited Support)
Alarms		8 IN / 4 OUT	4IN / 1 OUT	8 IN / 4 OUT	8 IN / 4 OUT
Hard Disk		1 SATA (8 TB Max)	2 SATA (10 TB Max)	2 SATA (10TB each)	2 SATA (10TB each)



NVR 32 CH

Real-time recording of all channels, H.265, Backup format AVI/DAT/MP4, VMS Support, Provision Cam2 APP Support, Remote connection via APP & Web page.

		NVR12-32800FAN(1U)	NVR12-32800RFAN(2U)	NVR12-32800FN-16P(2U)
				
Channels		32	32	32
Max. resolution		12 MP	12 MP	12 MP
Cyber Security				
NDAAs				
Video output		HDMI: 4K HDMI2 + VGA: 1080P	HDMI: 4K HDMI2 + VGA: 1080P	HDMI: 4K HDMI2 + VGA: 1080P
POE Ports / CCTV mode		-	-	16 - CCTV Mode (200m)
A.I.	DDA™	Yes	Yes	Yes
	Face Recognition	Yes	Yes	Yes
	LPR	Yes	Yes	Yes
Snapshots A.I.	Live View by menu	Yes	Yes	Yes
		Yes	Yes	Yes
Fish-Eye Dewarp		Yes	Yes	Yes
Thermal Support		Yes	Yes	Yes
Alarms		8 IN / 4 OUT	16 IN / 4 OUT	16 IN / 1 OUT
Hard Disk		2 SATA (10TB each)	8 x SATA (Up to 10TB each) 2 x E-SATA (Up to 10TB each)	8 x SATA (Up to 10TB each) 1 x E-SATA (Up to 10TB each)

NVR
64-128 CH

Real-time recording of all channels, H.265, Backup format AVI/DAT/MP4, VMS Support, Provision Cam2 APP Support, Remote connection via APP & Web page.

		NVR16-641600RFAN(2U)	NVR16-128RFAN(3U)
		 <small>RAID support</small>	 <small>RAID support</small>
Channels		64	128
Max. resolution		8 MP	8 MP
Cyber Security			
NDAA			
Video output		HDMI1: 4K HDMI2+VGA: 1080P	HDMI1: 4K HDMI2+VGA: 1080P
POE Ports / CCTV mode		-	-
A.I.		Yes	Yes
	Face Recognition	-	-
	LPR	Yes	Yes
Snapshots A.I.	Live View	Yes	Yes
	by menu	Yes	Yes
Fish-Eye Dewarp		Yes	Yes
Thermal Support		(Limited Support)	(Limited Support)
Alarms		8 IN / 4 OUT	8 IN / 4 OUT
Hard Disk		8 x SATA (Up to 10TB each) 2 x E-SATA (Up to 10TB each)	16 x SATA (Up to 10TB each) 2 x E-SATA (Up to 10TB each)

Switch PoE

Switch PoE

STANDARD 10/100 Mbps

Synonymous with high reliability and easy installation, Provision-ISR's 10/100 Mbps PoE line has been meticulously designed for standard IP surveillance systems.

With options of 4/8/16/24 ports, standard up-link, and SFP ports (depending on the model), this line offers a suitable solution for any type of installation.

All models comply with IEEE 802.3 and automatically detect power-consuming devices (PD) and their energy consumption level.

SWITCH POE PROFESSIONAL 10/100/1000 Mbps

The 1,000Mbps (gigabit) PoE switches are designed for security industry professionals.

The models with 16/24 ports feature an LCD monitor located on the front panel, which allows for viewing the following system information: Single channel output power (W), Overload protection (OLP), Short circuit protection (SCP), Low voltage/Overvoltage alarms, High temperature alarms.

SWITCH POE LCD

An intuitive Color LCD panel positioned on the front of the switch Simplifies Ethernet and PD PoE management.

The LCD panel enables efficient management of large-scale networks, such as enterprises, hotels, shopping malls, government buildings, and other public areas. It provides various special management and status functions, including PoE management and status, port management and status, switch mode, bandwidth control, PD control, and maintenance checks.



KEEP ALIVE

The "KEEP ALIVE" feature of Provision-ISR's PoE switches is designed to detect a malfunctioning Powered Device (PD) that has caused communication disruption.

The feature restarts the hardware by removing and restoring the power supply.

If the connected camera is drawing power but not generating data traffic, it will be automatically restarted! This function can be individually set for each of the PoE ports!



CCTV MODE

The TVCC (Closed Circuit Television) mode is actually a preconfigured VLAN (not customizable by the user) that prevents all communications between the down-link ports.

The TVCC mode limits communication to 10 Mbps to increase stability.

The absence of communication between the down-link ports (VLAN) helps improve network security and data transmission efficiency.

By limiting the communication speed to 10 Mbps, the communication distance can be increased up to a maximum of 250 meters.

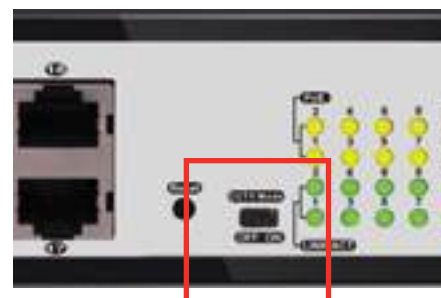

Switch PoE 10/100 Mbps

TVCC MODE: Up to 250m at 10 Mbps, no communication between down-link ports, PoE (8W Max), Surge protection. Compliant with IEEE802.3af/at.

	PoES-0460C+2I-V2 	PoES-08120C+2I-V2 
Down-link ports	4 x 10/100 Mbps	8 x 10/100 Mbps
Up-link ports	2 x 10/100 Mbps	2 x 10/100 Mbps
Total power	60W (Avg:15W Max 30W per ch)	120W (Avg:15W Max 30W per ch)
	PoES-16250C+2Combo V2 	FIBER POES-16250CL+2G+2SFP 
Down-link ports	16 x 10/100 Mbps	16 x 10/100 Mbps
Up-link ports	2 x 10/100/1000 Mbps	2 x 10/100/1000 Mbps + 2 X SFP
Total power	250W	250W (Avg:15.6W Max 30W per ch)
Keep alive	Yes	Yes
Display	-	Color LCD
	PoES-24370C+2 Combo 	FIBER POES-24370CL+2G+2SFP 
Down-link ports	24 x 10/100 Mbps	24 x 10/100 Mbps
Up-link ports	2 x 10/100/1000 Mbps	2 x 10/100/1000 Mbps + 2 x SFP
Total power	370W (Avg:12.5W Max 30W per ch)	370W (Avg:15.4W Max 30W per ch)
Keep alive	-	Yes
Display	-	Color LCD

Switch PoE 10/100/1000 Mbps

TVCC MODE: Up to 250m at 10 Mbps, no communication between down-link ports. PoE (8W Max), Surge protection. Compliant with IEEE802.3af/at.

	PoES-0472GC+2G 	PoES-08120GC+2GI 
Down-link ports	4 x 10/100/1000 Mbps	8 x 10/100/1000 Mbps
Up-link ports	2 x 10/100/1000 Mbps	2 x 10/100/1000 Mbps
Total power	72W (Avg:18W Max 30W per ch)	120W (Avg:15W Max 30W per ch)
Keep alive	-	-
Display	-	-
	FIBER PoES-08120GCL+2combo 	FIBER POES-16250GCL+2SFP 
Down-link ports	8 x 10/100/1000 Mbps	16 x 10/100/1000 Mbps
Up-link ports	2 x 10/100/1000 Mbps + 2 x SFP	2 x SFP
Total power	120W (Avg:15.4W Max 30W per ch)	250W (Avg:15.6W Max 30W per ch)
Keep alive	Yes	Yes
Display	Color LCD	Color LCD

Switch PoE 10/100/1000 Mbps

TVCC MODE: Up to 250m at 10 Mbps, no communication between down-link ports. PoE (8W Max), Surge protection. Compliant with IEEE802.3af/at.

POES-24370GCL+2SFP

FIBER



Down-link ports	24 x 10/100/1000 Mbps
Up-link ports	2 x SFP
Total power	370W (Avg:15.4W Max 30W per ch)
Keep alive	Yes
Display	Color LCD

Powered Device Switch PoE 10/100/1000 Mbps

Surge protection.
Compliant with IEEE802.3af/at.

PoES-0460G+1G(HPD)



Down-link ports	4 x 10/100/1000 Mbps
Up-link ports	1 x 10/100/1000 Mbps (Powered Device)
Total power	55W (Avg:13.75W Max 30W per ch)
Power supply	Ethernet injector POE PoEI-0160 (Non incluso)

PoE Accessories

PoESP-0124W SPLITTER ETHERNET 1 CH POE

- Adjustable output: 5VDC/2A, 9VDC/2A o 12VDC/2A
- Maximum Power Output: Up To 24W
- Short-Circuit Protection
- High Efficiency DC/DC Converter



PoESP-0172W SPLITTER ETHERNET 1 CH POE

- Output: 24VDC / 3A
- Maximum Power Output: Up To 72W
- Short-Circuit Protection
- High Efficiency DC/DC Converter
- DC Jack / Terminal Connector Output



PoEI-0130 | PoEI-0190 ETHERNET INJECTOR 1 CH POE

- Down-link: 1x 100 Mbps
- Output: PoEI-0130 max 30W - PoEI-0190 max 90W
- Internal power supply (require 110/220AC input)
- Distance: up to 100 Meters
- Built-in surge protection



PoER-01 EXTENDER (REPEATER) 1 CH POE

- Extends PoE Ethernet range up to additional 100 meters (10/100Mbps Ethernet)
- No additional power supply is required
- Automatically detects and protects PoE equipment from being damaged by incorrect installation



PoER-02 EXTENDER (REPEATER) 1 TO 2 CH POE

- Extends PoE range up to additional 150 Meters (10/100Mbps Ethernet)
- 11 ch Input / 2 Ch Output
- No additional power supply is required
- Automatically detects and protects PoE equipment from being damaged by incorrect installation



DCoE-01 NON-POE POWER OVER ETHERNET CONVERTER

- Set-Transmitter/Receiver
- 50 Meters working distance
- Camera DC power supply needed
- Supplies DC power input to the camera - Not PoE



HD Series

Cameras



Basic

2MP -3K

Series marked for the installer looking for a high-level camera emphasizing the difference in image quality.
The Pro series cameras are suitable for indoor and outdoor applications where professional video surveillance is required.



Pro

2MP - 3K - 8MP

Series marked for the installer looking for a high-level camera emphasizing the difference in image quality.
The Pro series cameras are suitable for indoor and outdoor applications where professional video surveillance is required.

Provision-ISR HD range also includes:

A series of PTZ cameras for wide-area coverage

A series of special cameras specifically designed for non-conventional applications (box, hidden and PIR cameras)

HD Cameras

Model name index

HD Cameras

Example	Category	Sub-Category	CMOS	Resolution	Lux	Solution	Lens	Color
	D	I	-	3	8	0	A	28
I	2	-	3	8	0	A	28	

Category		CMOS	LUX	Lens	
B	Body	3 ~ 1/3"	0 0 (IR on)	28	2.8mm
D	Dome		1 0.01	36	3.6mm
I	Infra-Red (IR) Bullet		2 0.01 ~ 0.1	37	3.7mm
M	Mini			VF	Vari-focal
IV	IR PIR detector			MVF	Motorized VF (with auto focus)

Sub-Category		Resolution	Solution	Color
X	No subcategory	2 2 MP	AB Basic	G Grey
AI	Anti vandal (IR)	3K 3K	A 4 in 1 Pro	
C	Pinhole cone shape	5 5 MP	AR Rainbow	
I	Infra red (IR)	8 8 MP		
L	Spotlight shape			
S	Smoke detector			
V	White Led			
W	Snake			
2	IR 20 m			
4	IR 40-60 m			

PTZ

Example	IR distance	Category	CMOS	Resolution	LUX	Solution	Zoom
	I5	50 m	PT Pan Tilt	3 ~ 1/3"	9 2 MP	0 0 (IR on)	A HD

Speed dome

Example	Category	Lens	Solution	Resolution	Special features
	MZ	Mini Speed dome	10 x10 zoom	A HD	2 2 MP
ZP	Speed dome	20 x20 zoom			



Basic 2 MP

HD/TVI/CVI/CVBS + PAL/NTSC (DIP Switch)

	DI-320AB-28	I2-320AB-28
		
Lens	2.8mm (90°)	2.8mm (90°)
Illumination	20m (1 High Power IR LED)	20m (1 High Power IR LED)
Power supply	DC12V/220mA	DC12V/220mA
Brackets/ Junction Box	Pag. 62 - G	Pag. 62 - G



Basic 3K



HD/TVI/CVI/CVBS + PAL/NTSC (DIP Switch)

	DI-33K0AB-28	I2-33K0AB-28
		
Lens	2.8mm (90°)	2.8mm (90°)
Illumination	20m (1 High Power IR LED)	20m (1 High Power IR LED)
Power supply	DC12V/195mA	DC12V/195mA
Brackets/ Junction Box	Pag. 62 - G	Pag. 62 - G



Pro 2 MP

HD/TVI/CVI/CVBS + PAL/NTSC (DIP Switch)

	DI-320A-28	DV-320AR-36	DI-320A-VF	DI-320A-VF-G
		 rainbow COLOR NIGHT VISION		
Lens	2.8mm (88°)	3.6mm (84.6°)	2.8-12mm Vari-Focal (88°-33°)	
Illumination	1 LED Array (20m)	25m (2 High-Power White LED)	3 LED Array (40m)	
Power supply	DC12V/270mA	DC12V/300mA	DC12V/620mA	
Brackets/ Junction Box	Pag. 66 - G	Pag. 66 - G	Pag. 66 - F	



	I2-320A-28	BSV-320AR-36
		 
Lens	2.8mm (88°)	3.6mm (84.6°)
Illumination	1 LED Array (20m)	25m (2 High-Power White LED)
Power supply	DC12V/270mA	DC12V/300mA
Brackets/ Junction Box	Pag. 66 - G	Pag. 66 - G



	I4-320A-28	I4-320A-VF	I4-320A-VF-G
			
Lens	2.8mm (88°)	2.8-12mm Mega-Pixel Vari-Focal (96°-34°)	
Illumination	40m (2 High-Power IR LED)	40m (2 High-Power IR LED)	
Power supply	DC12V/270mA	DC12V/300mA	
Brackets/ Junction Box	Pag. 66 - G	Pag. 66 - G	



Pro 3K

HD/TVI/CVI/CVBS + PAL/NTSC (DIP Switch)



	DI-33K0AP-28	DI-33K0AP-MVF	DI-33K0AP-MVF-G
			
Lens	2.8mm (88°)	2.8-12mm Mega-Pixel Motorized Vari-Focal (104°-38°)	
Illumination	1 LED Array (20m)	25m (2 High-Power White LED)	
Power supply	DC12V/270mA	DC12V/300mA	
Brackets/ Junction Box	Pag. 66 - G	Pag. 66 - G	



	I2-33K0AP-28	I4-33K0AP-28	I4-33K0AP-MVF
			
Lens	2.8mm (100°)	2.8mm (100°)	2.8-12mm MVF (103°-38°)
Illumination	20m (1 High-Power IR LED)	40m (1 High-Power IR LED)	40m (1 High-Power IR LED)
Power supply	DC12V/250mA	DC12V/400mA	DC12V/450mA
Brackets/ Junction Box	Pag. 62 - G	Pag. 62 - G	Pag. 62 - G



Pro 8MP

HD/TVI/CVI/CVBS + PAL/NTSC (DIP Switch)

	DI-380A-28	DI-380A-MVF
		
Lens	2.8mm (89.3°)	2.8-12mm Motorized Vari-Focal (78°-31.3°)
Illumination	1 LED Array (20m)	3 LED Array (40m)
Power supply	DC12V/270mA	DC12V/620mA
Brackets/ Junction Box	Pag. 66 - G	Pag. 66 - F

	DAI-380A-MVF	I2-380A-28	I4-380A-MVF
			
Lens	2.8-12mm Motorized Vari-Focal (83.5°-32°)	2.8mm (95°)	2.8-12mm Motorized Vari-Focal (82.5°-31.5°)
Illumination	3 LED Array (40m)	1 LED Array (20m)	2 LED Array (40m)
Power supply	DC12V/320mA	DC12V/470mA	DC12V/560mA
Brackets/ Junction Box	Pag. 66 - H	Pag. 66 - A	Pag. 66 - B





Pro 2MP

HD/TVI/CVI/CVBS + PAL/NTSC (DIP Switch)

	IV-390A37-V2	MW-392A37	MC-392A37
			
Lens	Lens Pinhole 3.7mm (78°)	3.7mm Pinhole Lens (83°)	3.7mm Pinhole Lens (78°)
Illumination	10m (18 IR LED)	-	-
Power supply	DC12V±10%, ~212mA	DC12V±10%, ~80mA	DC12V±10%, ~72mA

PTZ 2MP

HD/TVI/CVI/CVBS + PAL/NTSC (DIP Switch)

	I5PT-390AX4	I5PT-390AX10
		
Lens	4X (2,8-12mm)	10X (5,1-52mm)
Pan/Tilt range	250° horizontal - 65° vertical	250° horizontal - 65° vertical
IR Distance	50m (IR LED ARRAY)	50m (IR LED ARRAY)
Power supply	DC12V/2A	DC12V/2A

	MZ-10A-2(IR)	ZE-20A-2(IR)	ZP-20A-2(IR)
			
Lens	x10 (4.7-47mm)	20X(4.9-97mm)	20X (4.9-97mm)
Pan/Tilt range	360° (Endless)/ 180° (Auto Flip)	360° (Endless)/ 180° (Auto Flip)	360° (Endless)/ 180° (Auto Flip)
IR Distance	60m IR LED	100m IR LED Array	100m IR LED Array
Power supply	DC12V/2A	12VDC/2A	24VAC/3A
Brackets/ junction box			



DVR

Digital Video Recorders

DVR systems are the “heart” of any CCTV installation.

All information streamed from the cameras accumulates in the DVR. The DVR captures the video signal coming from the camera, converts and saves it in digital format.

Therefore, the DVR’s quality is as important as the cameras’ when it comes down to the final video resolution. Moreover, since all the recording data is saved and rewritten repeatedly on the DVR, it must be an extremely reliable and high-standard product. Provision-ISR DVRs are designed and manufactured according to researched and practiced knowledge over many years of experience.

All DVRs use the advanced H.264-H.265 video compression format to deliver maximum video quality while using minimum storage volume.

Provision-ISR DVRs are made of the highest quality components and are adapted to work in a wide range of different conditions and applications.

All of our DVRs stand out for their “full feature” operating system with a user-friendly graphical interface running from its powerful processor.

Depending on the model, our DVRs include digital VGA and HDMI monitor out, Analogue video out, audio in/out, RS-485 for PTZ control, and alarm in/alarm out sockets.





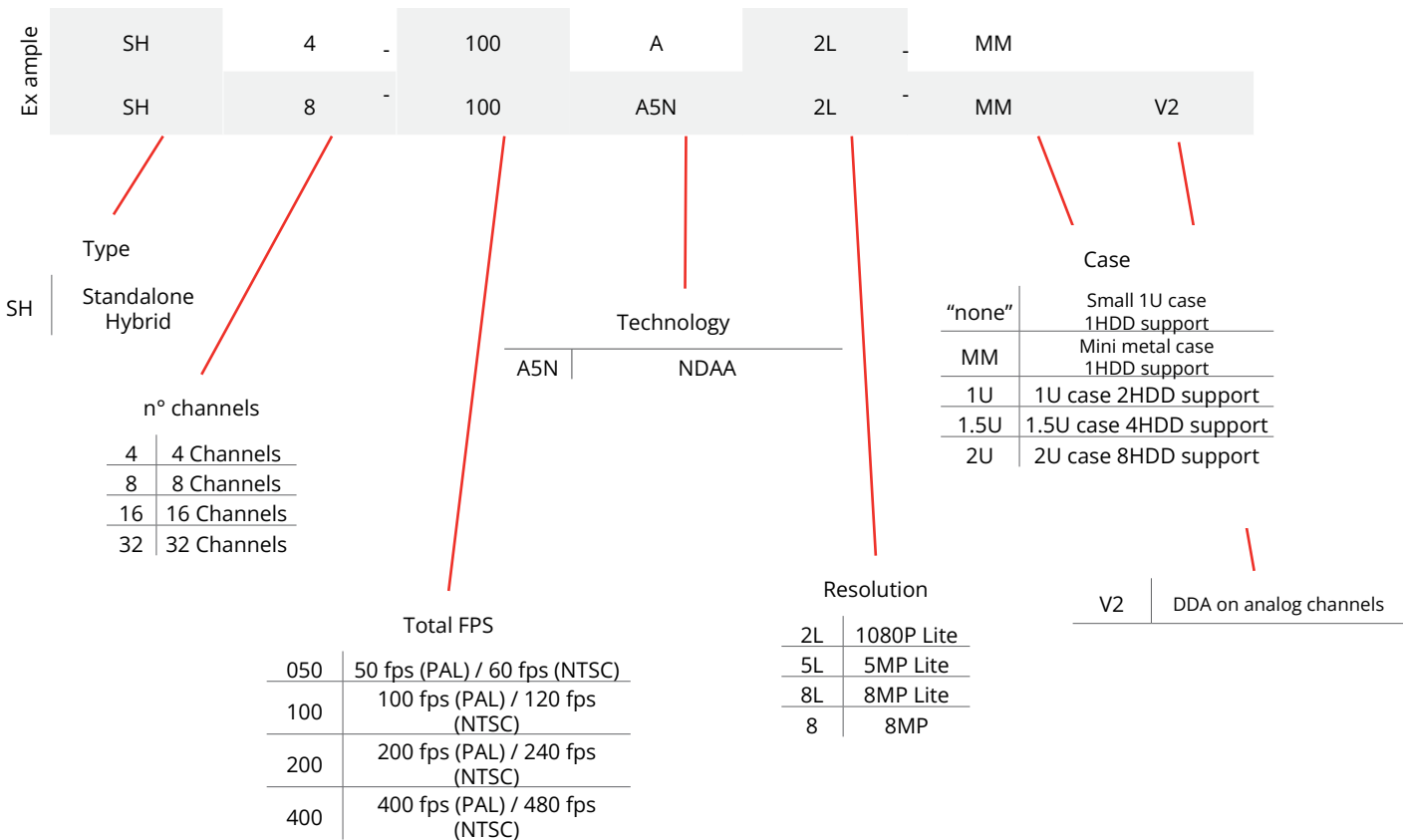



The range of DVRs is also supported by a robust network function for remote monitoring, complete remote configuration and mobile device application for remote monitoring.

Model name index









HYBRID DVR 4 Ch

Dynamic hybrid, HD / CVI / TVI / CVBS + IP, H.265, Backup format AVI/DAT, VMS Support, Video Analytic Support, Provision Cam2 APP, Cloud connection: APP & Web page.

	SH-4100A5N-2L (MM)	SH-4100A5N-2L (MM)-V2	SH-4050A5N-5L(MM)-V2	 SH-4050A5N-8L(MM)-V2
				
Analog+IP Channels	4 + 2 / 0 + 6		4 + 2 / 0 + 6	4 + 2 / 0 + 6
Resolution	2 MP lite		5 MP lite	8 MP lite
NDAA				
Video output	HDMI: 1080P VGA: 1280x1024		HDMI: 1080P VGA: 1280x1024 CVBS(Spot)	HDMI1: 4K HDMI2: 1080P VGA: 1280x1024 CVBS (spot)
Smart Motion Detection	-	Yes	Yes	Yes
DDA (On Analog Channels)	-	Yes	Yes	Yes
Max. Recording	Analog: 2MP Lite @ 25FPS IP: 3MP @ 25FPS		Analog: 5MP Lite @ 25FPS IP: 5MP @ 25FPS	Analog: 5MP Lite @ 25FPS IP: 5MP @ 25FPS
Audio	1 IN / 1 OUT		1 IN / 1 OUT	1 IN / 1 OUT
Alarms	IP Cameras only		IP Cameras only	IP Cameras only
Hard Disk	1 SATA (6 TB Max)		1 SATA (8 TB Max)	1 SATA (8 TB Max)







HYBRID DVR 8 Ch

Dynamic hybrid, HD / CVI / TVI / CVBS + IP, H.265, Backup format AVI/DAT, VMS Support, Video Analytic Support, Provision Cam2 APP, Cloud connection: APP & Web page.

	SH-8100A5N-2L(MM)-V2	SH-8100A5N-5L(MM)-V2	SH-8100A5N-5L-V2
			
Analog+IP Channels	8 + 2 / 0 + 10	8 + 4 / 0 + 12	8 + 4 / 0 + 12
Resolution	2 MP lite	5MP lite	5MP lite
NDAA			
Video output	HDMI: 1080P VGA: 1280x1024	HDMI: 1080P VGA: 1280x1024 CVBS (Spot)	HDMI: 1080P VGA: 1280x1024 CVBS (Spot)
Smart Motion Detection	Yes	Yes	Yes
DDA (On Analog Channels)	Yes	Yes	Yes
Max. Recording	Analog: 2MP Lite @ 25FPS IP: 5MP @ 25FPS	Analog: 5MP Lite @ 25FPS IP: 5MP @ 25FPS	Analog: 5MP Lite @ 25FPS IP: 5MP @ 25FPS
Audio	1 IN / 1 OUT	1 IN / 1 OUT	8 IN / 1 OUT
Alarms	IP Cameras only	IP Cameras only	8 IN / 2 OUT
Hard Disk	1 SATA (6 TB Max)	1 SATA (6 TB Max)	1 SATA (10 TB Max) 1 ESATA port





HYBRID DVR 8 Ch

Dynamic hybrid, HD / CVI / TVI / CVBS + IP, H.265, Backup format AVI/DAT, VMS Support, Video Analytic Support, Provision Cam2 APP, Cloud connection: APP & Web page.

	 SH-8100A5N-8L(MM)	SH-8100A5N-8L(MM)-V2	 SH-8100A5N-8L(1U)-V2
			
Analog+IP Channels	8 + 8 / 0 + 16		8 + 8 / 0 + 16
Resolution	8MP lite		8MP lite
NDAAC			
Video output	HDMI1: 4K VGA: 1280x1024 CVBS (spot)		HDMI1: 4K VGA: 1280x1024 CVBS (spot)
Smart Motion Detection	-	Yes	Yes
DDA (On Analog Channels)	-	Yes	Yes
Max. Recording	Analog: 8MP Lite @ 25FPS IP: 8MP @ 25FPS		Analog: 8MP Lite @ 25FPS IP: 8MP @ 25FPS
Audio	1 IN / 1 OUT		8 IN / 1 OUT
Alarms	IP Cameras only		8 IN / 2 OUT
Hard Disk	1 SATA (8 TB Max) 1 ESATA port		2 SATA (8 TB Max) 1 ESATA port

HYBRID DVR 16 Ch

Dynamic hybrid, HD / CVI / TVI / CVBS + IP, H.265, Backup format AVI/DAT, VMS Support, Video Analytic Support, Provision Cam2 APP, Cloud connection: APP & Web page.

	SH-16200A5N-2L(MM)-V2	SH-16200A5N-5L(MM)-V2	SH-16200A5N-5L(1U)-V2	SH-16200A5N-8L(1U)-V2 
				
Analog+IP Channels	16 + 2 / 0 + 18	16 + 8 / 8 + 16	16 + 8 / 8 + 16	16 + 8 / 8 + 16
Resolution	2MP lite	5MP lite	5MP lite	8MP lite
NDAAC				
Video output	HDMI: 1080P VGA: 1280x1024 CVBS (Spot)	HDMI: 1080P VGA: 1280x1024 CVBS (Spot)	HDMI: 1080P VGA: 1280x1024 CVBS (Spot)	HDMI1: 4K HDMI2: 1080P VGA: 1280x1024 CVBS (spot)
Smart Motion Detection	Yes	Yes	Yes	Yes
DDA (On Analog Channels)	Yes	Yes	Yes	Yes
Max. Recording	Analog: 2MP Lite @ 25FPS IP: 5MP @ 25FPS	Analog: 5MP Lite @ 25FPS IP: 5MP @ 25FPS	Analog: 5MP Lite @ 25FPS IP: 5MP @ 25FPS	Analog: 8MP Lite @ 25FPS IP: 8MP @ 25FPS
Audio	1 IN / 1 OUT	1 IN / 1 OUT	8 IN / 1 OUT	8 IN / 1 OUT
Alarms	-	-	16 IN / 4 OUT	16 IN / 4 OUT
Hard Disk	1 SATA (6 TB Max) 1 ESATA port	1 SATA (6 TB Max) 1 ESATA port	2 SATA (8 TB Max) 1 ESATA port	2 SATA (8 TB Max) 1 ESATA port

**HYBRID
DVR 32 Ch**

Dynamic hybrid, HD / CVI / TVI / CVBS + IP, H.265, Backup format AVI/DAT, VMS Support, Video Analytic Support, Provision Cam2 APP, Cloud connection: APP & Web page.

SH-32400A5N-5L(1.5U)-V2



Analog+IP Channels	32+8 / 24+16
Resolution	5MP lite
NDAAs	 NDAAs Compliance
Video output	HDMI(1920x1080) VGA (1280x1024, 1024x768) CVBS(Spot)
Smart Motion Detection	Yes
DDA (On Analog Channels)	YEs
Max. Recording	Analog: 5MP Lite @ 25FPS IP: 5MP @ 25FPS
Audio	4 IN / 1 OUT
Alarms	4 IN / 1 OUT
Hard Disk	4 SATA (8 TB Max)

PRODUCT RANGE ACCESSORIES

The term “ONE STOP SHOP” is the definition that best represents Provision-ISR’s offering. The brand’s catalog includes a wide range of accessories to complement the product lineup: test monitors, power supplies, brackets, junction boxes, connectors, baluns, and everything a security professional needs to build and complete a CCTV system.

USB Alarm BOX



Expand the “Alarms” functionality of your device by using our plug-and-play IO-1606 Alarm Box! All you need to do is connect the “box” to your device using the provided USB cable and instantly get 16 Alarm inputs and 6 Alarm outputs!

Specifications

		IO-1606
Connectivity	Alarms Input	16 Dry contacts
	Alarms Output	6 Dry contacts
	Connection Interface	Micro USB
	Power supply	5VDC/1A
	Power Consumption	<5W
Housing	Bracket	Wall Mount
	Dimensions	140mmx74mmx29mm
	Weight(gross)	180g
	Work Environment	-10°C~50°C, 10%~90% Humidity

HDMI Accessories

PR-HDMItoVGA

HDMI to VGA

Converts HDMI to VGA output

- Supports: all HD formats up to 1080P @ 30Hz
- Support HDMI 1.4b
- No support for HDMI audio (Will be lost)
- No power required



PR-HDeX (4K)

HDMI Repeater

It repeats and regenerates an entering HDMI signal and allows a second HDMI cable for a total of 40m (131ft).

- Supports: all HD formats up to 4K @ 30Hz
- Support HDMI 1.4b
- Support up to 40 meters total transmission distance (AWG 26 cable standard)
- 1080P resolution: input up to 15 meters, output up to 25 meters
- 4K resolution: input up to 5 meters, output up to 8 meters
- Note: working distance may be affected by the cable quality and length.
- No power required



PR-SP102 (4K)

Splitter HDMI 1 a 2

It splits a single HDMI input signal into 2 identical output signals.

- Split one HDMI input signal into 2 HDMI output signals
- Support HDMI resolution up to 4K@30Hz
- Support digital audio format: DTS-HD/Dolby-true HD/DTS/Dolby-AC3/DSD/HD(HBR)
- Supported HDMI cable distance: (AWG 26 cable standard)
- 1080P resolution: input up to 15 meters, output up to 15 meters
- 4k resolution: input up to 8 meters, output up to 8 meters
- Note: Working distance may be affected by the cable quality and length.
- DC5V power supply needed (USB Power cable included)



PR-SP104 (4K)

Splitter HDMI da 1 a 4

It splits a single HDMI input signal into 4 identical output signals.

- Separate 1 HDMI in to 4 HDMI out
- Support HDMI resolution up to 4K@30Hz
- Support digital audio format: DTS-HD/Dolby-true HD/ DTS/ Dolby-AC3/ DSD/ HD(HBR)
- Supported HDMI cable distance: (AWG 26 cable standard)
- 1080p resolution: input up to 15 meters, output up to 15 meters
- 4k resolution: input up to 8 meters, output up to 8 meters
- Note: Working Distance may be affected by the cable quality and length
- Include DC5V power supply



PR-SW301 (4K)

HDMI Switcher 3 a 1

It incorporates the connection of 3 HDMI sources into a single HDMI display. After connection, you can select the input manually or automatically by the device.

- Compatible with HDMI 1.4a
- Support up to 4K@30Hz.
- Deep color 12bit per channel
- "Smart switching" function that can detect live HDMI signal in different channels and switch to it automatically
- No power supply required for standard installation. If the HDMI output cable exceeds 5m – a CD5V power supply will be required (Not included)



HDMI Accessories

PR-4IN1-Con

Analogue HD to HDMI/VGA/BNC Converter

It converts the Analogue HD signal to an HDMI/VGA/BNC signal for direct connection to a standard display

- Up to HD 2MP signals (AHD/CVI/TVI/CVBS)
- HDMI output compatible with HDCP, HDMI1.4
- HDMI output resolutions: 720P@50/60Hz, 1080P@50/60Hz
- VGA output resolutions: 800x600@60Hz, 1024x768@60Hz, 1366x768@60Hz, 1280x720@60Hz, 920x1080@60Hz
- Selectable output and resolution by a physical button on the device
- Supports both NTSC/PAL Video inputs -Automatic detection
- Maximum output distance: HDMI: 20 meters, VGA: 5 meters, CVBS: 500 meters



PR-HDoNet-E

HDMI extender su Cat5e/Cat6

It converts the Analogue HD signal to an HDMI/VGA/BNC signal for direct connection to a standard display

- Working distance: up to 10m distance over cat5e cable, up to 20m over Cat6 cable
- HDMI 1.3&3D support
- Support video resolution of up to 1080P@60Hz
- Support format audio: DTS-HD/Dolby-true HD/LPCM7.1/DTS/Dolby AC3/DSD
- Power supply not required



PR-HDoNet+

HDMI extender su Cat5e/Cat6

It converts the Analogue HD signal to an HDMI/VGA/BNC signal for direct connection to a standard display

- Working distance: up to 40m distance over cat5e cable, up to 60m over Cat6 cable
- HDMI 1.3&3D support
- 12Bit deep color and bandwidth of up to 225Mhz support
- Support video resolution of up to 1080P@60Hz
- Supported Audio formats: DTS-HD/Dolby-true HD/LPCM7.1/DTS/Dolby- AC3/DSD
- IR signal transmission (PR-HDoNet(IR) model only)
- DC5V power supply included



PR-HDKVMoNet

Extender HDMI USB KVM su Cat5r/Cat6

It transmits HDMI + USB + IR signals over Ethernet cable

- Working distance: up to 100m distance over cat5e cable, up to 130m over Cat6 cable
- HDMI1.3 & 3D Support
- 12Bit deep color and bandwidth of up to 225Mhz support
- Support video resolution of up to 1080P@60Hz
- Supported Audio formats: DTS-HD/Dolby-true HD/LPCM7.1/DTS/ DolbyAC3/DSD
- Support USB2.0 Keyboard and mouse transmission
- Support IR signal transmission
- DC5V power supplies included



Balun / High power balun

PTR-101V-HD-8

1CH 8MP Video Passive Balun

- Passive transmission - No power required
- 8MP 4in1 support: AHD / CVI / TVI / CVBS.
- Transmission Distance: AHD / CVBS - 200M / CVI / TVI - 150M. •Friendly "Tool Free" Terminal Connector
- Built-in TVS for Surge Protection
- Anti-Static Design
- Wave Filter Design
- Designed for Cat.5e/6 Cables



PTR-102VP-HD-8

1CH 8MP Video + Power Passive Balun

- Passive transmission - No additional power required
- 8MP 4in1 support: AHD / CVI / TVI / CVBS.
- Transmission Distance: AHD / CVBS - 200M, CVI / TVI - 150M
- Friendly "Tool Free" Terminal Connector
- Built-in TVS for Surge Protection
- Anti-Static Design
- Wave Filter Design
- Designed for Cat.5e/6 Cables



PTR-103VHP-HD

1CH HD Balun video + High power

- Passive transmission - No additional power required
- 5MP 4in1 support: AHD / CVI / TVI / CVBS
- Transmission Distance: AHD / CVBS / CVI / TVI- 200M
- Friendly "Tool Free" Terminal Connector
- Built-in TVS for Surge Protection
- High-Power Input: 12-36VDC
- Power output: 12VDC Stable Output
- Anti-Static Design
- Wave Filter Design
- Designed for Cat.5e/6 Cables

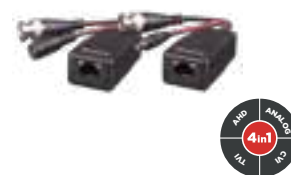

Connectors

PR-C01



CONNECTOR
BNC male to RCA female

PR-C03



"T" CONNECTOR BNC
Male to 2 BNC female

PR-C04



CONNECTOR
BNC female to RCA male

PR-C07



CONNECTOR
BNC female to BNC
female

PR-C08



CONNECTOR
DC jack male

PR-C09



CONNECTOR
DC jack female

PR-C10



DC CABLE WITH MALE
JACK 25 cm length

PR-C12



BNC PLUG

PR-C13



BNC PLUG
(one set with three pcs)
for ratchet BNC cramping
tool

PR-C14



DC SPLITTER 1-4

Power supplies

PR-12V1A-A

Power supply 12V 1A

- Stable power signal to support clear images
- Over-current protection
- Short circuit protection



PR-12V3A

Power supply 12V 3A

- Stable power signal to support clear images
- Over-current protection
- Short circuit protection



PR-12V5A

Power supply 12V 5A

- Stable power signal to support clear images
- Over-current protection
- Short circuit protection



PR-12V5A-4

Power supply 12V 1A +4 SPLITTER

- Stable power signal to support clear images
- Over-current protection
- Short circuit protection



PR-12V5A-4T

Terminal block 12VDC 5A power supply

- Stable power signal to support clear images
- Over-current protection
- Short circuit protection



PR-5A8CH+

8 CH Power supply

- Output Voltage: DC12V
- Output Current: 5 Amp
- Backup Battery Support: No



PR-5A8CH-B

8 CH Power supply

- Output Voltage: DC12V
- Output Current: 5 Amp
- Backup Battery Support: Si (up to 7Ah)



PR-10A9CH+

9 CH Power supply

- Output Voltage: DC12V
- Output Current: 10 Amp
- Backup Battery Support: No



PR-10A9CH-B

9 CH Power supply

- Output Voltage: DC12V
- Output Current: 10 Amp
- Backup Battery Support: Si (up to 17Ah)



PR-12A16CH+

16 CH Power supply

- Output Voltage: DC12V
- Output Current: 12 Amp
- Backup Battery Support: No



PR-20A16CH (1U)

16 CH Power supply

- Output Voltage: DC12V
- Output Current: 20 Amp
- Backup Battery Support: No



Monitor

PR-IPS7-W

7" TFT Digital Monitor Dual-Input

- | | |
|------------------------------------------------------------------------------------------------------------------------------------------------------------------------------------------------------------------------------------------------------------------------|-----------------------------------------------------------------------------------------------------------------------------------------------------------------------------------------------------------------------------------------------------------------------------|
| <ul style="list-style-type: none"> • Screen Size: 7" TFT Screen • Resolution: 1024x600 • TV System: PAL / NTSC • Power Supply: DC 12V, 1A • Video Input: 1VP-P, 75Ohm • Inputs: AV1, AV2, VGA, HDMI, Power | <ul style="list-style-type: none"> • Work Temperature: -10°C ~ 60°C • Viewing Angle: 85° (All Directions) • Contrast Ratio: 300:01:00 • Brightness: 320CD/m2 • Weight: 0.80Kg • Dimension: 177W x 117H x 15D mm |
|------------------------------------------------------------------------------------------------------------------------------------------------------------------------------------------------------------------------------------------------------------------------|-----------------------------------------------------------------------------------------------------------------------------------------------------------------------------------------------------------------------------------------------------------------------------|



PR-IPS10-W

10" TFT Digital Monitor Multi-Input

- | | |
|-------------------------------------------------------------------------------------------------------------------------------------------------------------------------------------------------------------------------------------------------------------------|------------------------------------------------------------------------------------------------------------------------------------------------------------------------------------------------------------------------------------------------------------------|
| <ul style="list-style-type: none"> • Screen Size 10" TFT Screen • Resolution 1024x600 • TV System PAL / NTSC • Power Supply DC 12V, 1A • Video Input 1VP-P, 75Ohm • Inputs AV1, AV2, VGA, HDMI, Power | <ul style="list-style-type: none"> • Work Temperature -10°C ~ 60°C • Viewing Angle 85° (All Directions) • Contrast Ratio 300:1 • Brightness 350CD/m2 • Weight 1.2Kg • Dimension 250W x 163H x 16D mm |
|-------------------------------------------------------------------------------------------------------------------------------------------------------------------------------------------------------------------------------------------------------------------|------------------------------------------------------------------------------------------------------------------------------------------------------------------------------------------------------------------------------------------------------------------|



Test Monitor

TM-434in1-8

4.3" TFT LCD Test monitor

- | | |
|-----------------------------------------------------------------------------------------------------------------------------------------------------------------------------------------------------------------------------------------------------------------------------------------------|-----------------------------------------------------------------------------------------------------------------------------------------------------------------------------------------------------------|
| <ul style="list-style-type: none"> • 8MP 4in1 support: AHD / CVI / TVI / CVBS • Image settings support • 12VDC Output (Plug Supplied) • 5VDC Output (Micro USB Plug Supplied) • Audio in with Built-in Speaker • PAL/NTSC Support | <ul style="list-style-type: none"> • Status LED Indicators • Built-In Long-Life Rechargeable Battery • Hands-Free Operation (Arm strap supplied) • Light Weight |
|-----------------------------------------------------------------------------------------------------------------------------------------------------------------------------------------------------------------------------------------------------------------------------------------------|-----------------------------------------------------------------------------------------------------------------------------------------------------------------------------------------------------------|



TM-54in1-2

5" TFT LCD Test monitor

- | | |
|-----------------------------------------------------------------------------------------------------------------------------------------------------------------------------------------------------------------------------------------------------------------------------------------------------|---------------------------------------------------------------------------------------------------------------------------------------------------------------------------------------------------------------------------------------|
| <ul style="list-style-type: none"> • 2MP 4in1 support: AHD / CVI / TVI / CVBS • BNC x 1, VGA x 1 Input • Image settings support • 12VDC Output (Plug Supplied) • 5VDC Output (Micro USB Plug Supplied) • Audio in with Built-in Speaker | <ul style="list-style-type: none"> • PAL/NTSC Support • Status LED Indicators • Built-In Long-Life Rechargeable Battery • Hands-Free Operation (Arm strap supplied) • Light Weight |
|-----------------------------------------------------------------------------------------------------------------------------------------------------------------------------------------------------------------------------------------------------------------------------------------------------|---------------------------------------------------------------------------------------------------------------------------------------------------------------------------------------------------------------------------------------|



TM-54in1-8

5" TFT LCD Test monitor

- | | |
|-----------------------------------------------------------------------------------------------------------------------------------------------------------------------------------------------------------------------------------------------------------------------------------------------------|---------------------------------------------------------------------------------------------------------------------------------------------------------------------------------------------------------------------------------------|
| <ul style="list-style-type: none"> • 8MP 4in1 support: AHD / CVI / TVI / CVBS • Image settings support • BNC x 1, VGA x 1 Input • 12VDC Output (Plug Supplied) • 5VDC Output (Micro USB Plug Supplied) • Audio in with Built-in Speaker | <ul style="list-style-type: none"> • PAL/NTSC Support • Status LED Indicators • Built-In Long-Life Rechargeable Battery • Hands-Free Operation (Arm strap supplied) • Light Weight |
|-----------------------------------------------------------------------------------------------------------------------------------------------------------------------------------------------------------------------------------------------------------------------------------------------------|---------------------------------------------------------------------------------------------------------------------------------------------------------------------------------------------------------------------------------------|



Keyboards

IP-Key02-V2

Keyboard controller for PTZ



IP-Key01-V2

Keyboard controller for PTZ



Lenses

02812DCMP-3 V2

Resolution	3MP			Relative Aperture	1.4±5%	
Focal-length	2.8-12mm±5%			Mount	CS	
Format	d. 6.6(1/2.7")(MAX)			Focus Range	0.2 m ~ ∞	
Angle of View	CMOS	Horizontal	Vertical	Diagonal	Weight	42g
	1/2.5"	/	/	/	Focus	Manual focus and zoom
	1/2.7"	103°-30.8°	74.4°-23.3°	138°-40°	Iris	Auto
	1/3"	91°-28°	67.5°-21.2°	120.8°-36°	Operating Temperature	-20C°~+60C°
	1/4"	73°-23.4°	44.8°-14.8°	87.6°-27.8°	Back Focal-length	6.52mm±0.1



0550DCMP-8

Resolution	8MP			Relative Aperture	F1.4±5%	
Focal-length	5-50mm±5%			Mount	CS	
Format	d. 7(1/2.7")(MAX)			Focus Range	0.3 m ~ ∞	
Angle of View	CMOS	Horizontal	Vertical	Diagonal	Weight	180.8g±5g
	1/2.5"	/	/	/	Focus	Manual
	1/2.7"	49.1°-5.6°	36.5°-4.2°	62.7°-7°	Iris	Auto
	1/3"	44.2°-5.1°	32.7°-3.8°	56°-6.3°	Operating Temperature	-20C°~+60C°
	1/4"	32.7°-3.8°	24.4°-2.8°	41.2°-4.7°	Back Focal-length	7.58mm



Amplified IP Horn Speaker

PR-HS15W-IP

IP ONVIF 15W Outdoor horn speaker

- Max SPL: 113dB
- Frequency Response: 300Hz~8KHz
- Power: PoE / DC12V
- Power Consumption: 15W Max
- Protection Rate: IP67
- Dimensions: 225*165*240mm



PR-HS30W-IP

IP ONVIF 30W Outdoor horn speaker

- Max SPL: 120dB
- Frequency Response: 350Hz~8KHz
- Power: PoE / DC12V
- Power Consumption: 30W Max
- Protection Rate: IP67
- Dimensions: 285*205*290mm



PR-WS15W-IP

IP ONVIF 15W Indoor horn speaker

- Max SPL: 101dB
- Frequency Response: 80Hz~20KHz
- Power: PoE / DC12V
- Power Consumption: 15W Max
- Protection Rate: IP55
- Dimensions: 296*196*157mm



Brackets and junction box

Products compatibility

A - Bullet I2



B - Bullet I4



C - Bullet I6



D - Fish-Eye



E - Mini dome



F - Turret/Dome Vari-focal



G - Turret/Dome fixed lens



H - Anti-vandal dome Vari-focal



I - Anti-vandal fixed lens



L - PTZ



Brackets and junction box

Products compatibility



Model	Brackets/Junction boxes		Installation							
Bullet I6	Wall IP66 PR-JB14IP66	Wall IP64 PR-JB14IP64	Wall PR-WB14	optional PR-B10EX PR-B20EX	Ceiling PR-CB14	optional PR-B10EX PR-B20EX	Pole PR-B50PB	optional PR-CB14	Corner PR-B50ECB	optional PR-CB14
Bullet I4	Wall IP66 PR-JB12IP66	Wall IP64 PR-JB12IP64	Wall PR-WB12	optional PR-B10EX PR-B20EX	Ceiling PR-CB12	optional PR-B10EX PR-B20EX	Pole PR-B50PB	optional PR-CB12	Corner PR-B50ECB	optional PR-CB12
Bullet I2	Wall IP66 PR-JB12IP66	Wall IP64 PR-JB12IP64	Wall PR-WB12	optional PR-B10EX PR-B20EX	Ceiling PR-CB12	optional PR-B10EX PR-B20EX	Pole PR-B50PB	optional PR-CB12	Corner PR-B50ECB	optional PR-CB12
IP Fish-EYE FISH-EYE	Wall IP66 PR-B50JB	OR	Wall PR-WB50	optional PR-B10EX PR-B20EX	Ceiling PR-CB50	optional PR-B10EX PR-B20EX				
IP DMA DMA	Wall A PR-B10JB	OR	Wall B PR-WB-A	OR	Wall PR-WB12	optional PR-B10EX PR-B20EX	Ceiling PR-CB12	optional PR-B10EX PR-B20EX		

Fish-EYE and DMA available only in IP Technology

Model	Brackets/Junction boxes			Installation									
Dome DI-VF	Wall A PR-WB-A	OR	Wall B IP66 PR-DJB14IP66	Wall IP66 PR-JB14IP66	IP64 PR-JB14IP64	Wall PR-WB14	optional PR-B10EX PR-B20EX	Ceiling PR-CB14	optional PR-B10EX PR-B20EX	Pole PR-B50PB	optional PR-WB14	Corner PR-B50ECB	optional PR-WB14
Dome DI-FIX	Wall A PR-WB-A	OR	Wall B IP66 PR-DJB12IP66	Wall IP66 PR-JB12IP66	IP64 PR-JB12IP64	Wall PR-WB12	optional PR-B10EX PR-B20EX	Ceiling PR-CB12	optional PR-B10EX PR-B20EX	Pole PR-B50PB	optional PR-WB12	Corner PR-B50ECB	optional PR-WB12
Dome DAI-VF	Wall * IP66 PR-JB14IP66	OR	Ceiling PR-ICB23	Wall PR-WB14	optional PR-B10EX PR-B20EX	Ceiling PR-CB14	optional PR-B10EX PR-B20EX	Pole PR-B50PB	optional PR-WB14	Corner PR-B50ECB	optional PR-WB14		
Dome DAI-FIX	Wall A PR-WB-A	OR	Wall B * IP66 PR-JB12IP66	Ceiling PR-ICB21	Wall PR-WB12	optional PR-B10EX PR-B20EX	Ceiling PR-CB12	optional PR-B10EX PR-B20EX	Pole PR-B50PB	optional PR-WB12	Corner PR-B50ECB	optional PR-WB12	

*For DAI installations, please remove the junction box's cover and connect the camera directly to the junction box.

Doorbell DB	Wall IP66 PR-JB1-DB	OR	Wall PR-WB15-DB	Intercom INT-320WIPN	PR-IWB-INT	Intercom MON-TCH7	PR-IWB-MON7
----------------	---------------------------	----	--------------------	-------------------------	------------	----------------------	-------------

IP - HD / PTZ and Speed Dome brackets

PR-B30C 	PR-B30P 	PR-B30EC 	PR-B30IC 	PR-B20C 
Ceiling bracket	Pole Mount Bracket	External Corner Bracket	Internal Corner Bracket	Ceiling Bracket

IP Intelligent auto-tracking PTZ







PR-WB-Z 	PR-CB-Z 	PR-ICB-Z 	PR-B50PB 	PR-B50ECB 
Wall bracket	Ceiling bracket	In-ceiling bracket	Pole Mount Bracket	External Corner Bracket

PR-B60ECB 	PR-B60PB 	PR-B70ECB 	PR-B70PB 	PR-WJB-Z 
External Corner Bracket	Pole Mount Bracket	External Corner Bracket	Pole Mount Bracket	Wall bracket

PR-WB-Z3 	PR-WJB-Z3 
Wall bracket	Wall bracket









Z3



 +  	OR	 +  
---------------------------------------------------------------------------------------------------------------------------------------------------------------------------------------------------------------------------------------------------------------	----	----------------------------------------------------------------------------------------------------------------------------------------------------------------------------------------------------------------------------------------------------------------







Z4



 +  	OR	 +  	OR		OR	
---------------------------------------------------------------------------------------------------------------------------------------------------------------------------------------------------------------------------------------------------------------	----	----------------------------------------------------------------------------------------------------------------------------------------------------------------------------------------------------------------------------------------------------------------	----	---------------------------------------------------------------------------------------	----	---------------------------------------------------------------------------------------







Z5



 +  	OR	 +  	OR	
---------------------------------------------------------------------------------------------------------------------------------------------------------------------------------------------------------------------------------------------------------------	----	----------------------------------------------------------------------------------------------------------------------------------------------------------------------------------------------------------------------------------------------------------------	----	---------------------------------------------------------------------------------------

Z6



 +  	OR	 +  	OR	
---------------------------------------------------------------------------------------------------------------------------------------------------------------------------------------------------------------------------------------------------------------	----	----------------------------------------------------------------------------------------------------------------------------------------------------------------------------------------------------------------------------------------------------------------	----	---------------------------------------------------------------------------------------

IP - HD / Brackets/Junction Box's

**PR-JB14IP66
PR-JB14IP66-G**



Bracket- Junction box for I6-/DI-VF, IP66

PR-JB14IP64



Bracket- Junction box for I6-/DI-VF, IP64

**PR-JB12IP66
PR-JB12IP66-G**



Bracket- Junction box for I4-/I2-/DI-Fix, IP66

PR-JB12IP64



Bracket- Junction box for I4-/I2-/DI-Fix, IP64

PR-B10JB



Junction box for DMA IP cameras

PR-B50JB



Junction Box For Fish-Eye Cameras

PR-DJB12IP66



Bracket- Junction box for DI-Fix, IP66

PR-DJB14IP66



Bracket- Junction box for DI-VF, IP66

**PR-WB-A
PR-WB-A-G**



Bracket - Wall bracket for DI-VF, DI-Fix, DAI-Fix, DMA

PR-WB14



Bracket - L shape bracket fits PR-JB14IP66

PR-WB12



Bracket - L shape bracket fits PR-JB12IP66

PR-WB50



Bracket - Wall bracket for FEI

PR-CB14



Bracket - Straight bracket fits PR-JB14IP66

PR-CB12



Bracket - Straight bracket fits PR-JB12IP66

PR-CB50



Bracket - Ceiling bracket for FEI

PR-B10EX



10 cm extension for junction box

PR-B20EX



20 cm extension for junction box

PR-B50ECB



External Corner Mount Bracket for Supporting Junction Boxes

PR-B50PB



Pole Mount Bracket for Supporting Junction Boxes and

PR-ICB21



Bracket - In-ceiling mount bracket for DAI-FIX

PR-ICB23



Bracket - In-ceiling mount bracket for DAI-VF

Ossia VMS Dedicated Hardware

Provision-ISR Ossia VMS is an advanced and reliable software designed for CCTV systems featuring multiple devices that are controlled from a Single reliable platform.

Ossia VMS comes with dedicated VMS hardware that are planned, designed, and built by Provision-ISR, with the sole purpose of running the video management software while dedicating 100% of the system resources to the task.

OC-MSCL-S(DT)-V2

Client / Management server

So Small. So powerful.

OC-MSCL-S(DT)-V2 server/workstation is mainly developed for small to medium-Sized security systems.

Provision-ISR delivers a winning solution to the field of security with designated hardware that runs embedded Ossia VMS.

This design makes the system far more stable, cost-worthy, and Simple to use. As a result, the device is fully dedicated to its task – CCTV management and operation.

Main Features

- 256 Channel support
- 64 Recorder support
- 8GB DDR RAM
- Live View and Playback
- E-Map Monitoring
- Analytics Support
- ONVIF Camera Support
- Auto Report Service Support
- PTZ Support
- Audio Support
- Alarm Support
- Mobile App Support



OC-MS-M(1U)

Management server

Provision-ISR's new management server makes a firm base for more extensive security systems to deal with the most demanding tasks.

Combining high performances and embedded Ossia VMS on the one hand and the ability to manage up to 512 channels on the other, the OC-MS-M(1U) makes a stable and robust solution for most security needs.

Main Features

- Pre-installed OSSIA VMS (Server + Client)
- 512 Channels license included
- Full WEB interface
- Total of 256 PC Clients / Mobile App Clients
- Up to 512 channels!
- Storage server compatibility
- Set & view AI analytics
- Face database management
- Fisheye special views support
- LPR Monitoring
- User Management
- Map support (including google maps)
- Decoder support
- Audio broadcast



OC-MS-XL(1U)-V2

Management server

Provision-ISR's new management server is designed to deal with the most demanding tasks and makes a firm base for more extensive security systems.

Combining high performances and embedded Ossia VMS on the one hand and the ability to manage up to 3K channels on the other, the OCMS-XL(1U) makes a stable and commanding solution for most security needs.

Main Features

- Pre-installed Ossia VMS (Server + Client)
- 512 Channels license included
- Full WEB interface
- Total of 256 PC Clients / Mobile App Clients
- Up to 3,000 channels!
- Storage server compatibility
- Set & view AI analytics
- Face database management
- Fish-eye special views support
- LPR Monitoring
- User Management
- Map support (including google maps)
- Decoder support
- Audio broadcast



Ossia VMS

Dedicated Hardware

OC-RS-16(3U)

Storage server

Maximum stability, reliability, and capacity

OC-RS-16(3U) has 16 Hot-Swap HDD trays, RAID capabilities, dual Ethernet, and a power supply.

Provision-ISR's Storage Server was planned, designed, and built for the sole purpose of storing massive amounts of data and keeping it as safe and redundant as it can be.



Main Features

- Data capacity increase - allows for a remarkable increase of playback history.
- Redundancy - thanks to RAID5, the data on the disks will be secured against disk faults and errors.
- Flexibility - hot-swap disk trays for fast disk insertion and removal.
- Dual PSU (power supply unit) - one is for backup in case of an electric failure.

DEC-0104N(1U)

Decoder

Provision-ISR DEC-0104(1U) decoder makes the difference when it comes to durability. The decoder can display up to 144 channels on four separate screens, taking the most resource-demanding task from the client – to itself.

The client is free to deal with the CCTV unexpected tasks such as handling events, playback, alarms, Etc.

Each of the 144 windows is dynamic: the user can choose to use it as a live window, playback window, or an alarm pop-up window!



Main Features

- 4 HDMI Output (Total)
- 2 x 4K Screen Output
- 1 HDMI Input
- Audio Support
- Live View
- Alarm Popup View
- Playback View
- PTZ control
- Up to 8MP Decoding

IP-KEY02 V2

Keyboard

Much more than a Simple accessory

Provision-ISR IP-KEY-02 keyboard is an excellent addition for control rooms, headquarters, or surveillance rooms.

It allows the control of numerous Decoders and IP PTZ cameras and the choice of the camera layout you want by a Single button press.

The operator can easily display up to 144 different channels located on four screens connected to the decoder and fully control IP PTZ cameras for a quick focus on a specific object in the scene.



Main Features

PTZ CAMERAS (IP ONLY)

- Total movement control
- Preset
- Cruise

DECODERS

- Layout control
- Live view
- Playback
- Alarm window
- PTZ control (IP and Analogue)
- Sequencing channels

Showcases



High voltage pole security

Innovative solution security system based on a Cellular modem and a solar panel. Used also on farms and remote sites



V.A.R. Portugal

High performance and reliability



FACE RECOGNITION NEW ZELAND POLICE

Law enforcement standard Privacy and cyber security



Advanced anti theft thecnology

Crime prevention



Hotel Marriot – Costa Rica

Worldwide presence in large projects



Aircraft security

Governmental grade Sensitive locations A tailor-made solution

Togheter is power

At Provision-ISR, collaboration is at our core.

We go beyond by providing full-scale technical and marketing support, forging seamless integrations with other industry leaders. Together, we navigate every challenge, ensuring shared success in a landscape of innovation and partnership.

Our Offices



Israel

11 Atir Yeda Street, Kfar Sava, Israel.
Postal Code: 4464310
+972 9 741 7511



China

Rm 102, Building B, Fuhai Technology Industrial Park, Yongfu Road, Fuyong Town, Bao'an District, Shenzhen City, China.
Postal Code: 518103
+86 755 26861420



Italy

71 Einstein Albert Street
52100 Arezzo (AR), Italy
+39 0575 382687

Our Logistic Warehouses



China

Rm 102, Building B, Fuhai Technology Industrial Park, Yongfu Road, Fuyong Town, Bao'an District, Shenzhen City, China.
Postal Code: 518103
+86 755 26861420



America

ILS Cargo
11459 NW 122nd Street
Medley, Florida, USA
Postal Code: FL 33178



Europe

Harnaschdreef 12
2635 BT Den Hoorn
Netherlands

Stay connected!





Provision-ISR

11 Atir Yeda St, Kfar Saba, Israel
Postal Code: 4442510
Tel: (972-9) 741 7511
Fax: (972-9) 745 7182
www.provisionisr.com